

Zodiac Counters

Robust aluminium frames with
a rigid, white, powder coated
top and internal shelves

Perfectly simple

Folding Counters & Showcases



Perfectly simple

Zodiac Counters have a stock range of sizes and accessories – sliding lockable doors – base shelves – header signs - wheels – transport bags and cases. These counters work as an individual unit or as a group.



Contents

Range 1	4-5
Range 2	6-7
Range 3	8-9
Range 4	10-11
Range 5	12
CGIs & Specifications	13-19

SHOWCASES



ACCESSORIES



RANGE

1

Zodiac Counters

PC-1-H



PC-2-H



PC-6-H



Sliding Lockable Doors

Transport Case

Nylon Bag



Specification

PC-1-H

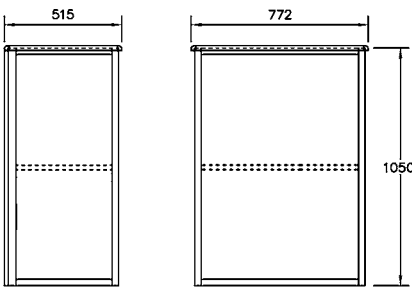

Zodiac counter 772 x 515 x 1050mm

Folded in a carton 1060 x 800 x 140mm (11kg)

3mm panel set 1 x 697 x 997 + 2 x 432 x 997mm (2.5kg)

Sliding door set in a carton 1100 x 750 x 60mm (6kg)

Accessories: Nylon bag

Transport Case†: 1190 x 830 x 240mm* (13kg*)

Bottom Shelf - Base panel (2kg)

PC-2-H

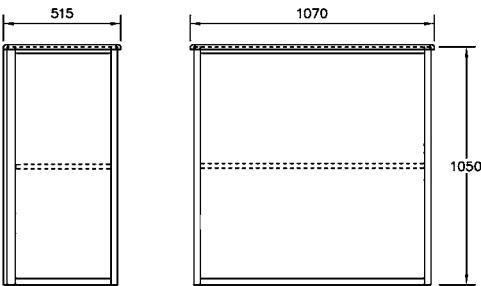

Zodiac counter 1070 x 515 x 1050mm

Folded in a carton 1100 x 1060 x 150mm (13kg)

3mm panel set 1 x 995 x 997 + 2 x 432 x 997mm (3kg)

Sliding door set in a carton 1100 x 750 x 60mm (8kg)

Accessories: Nylon bag

Transport Case†: 1200 x 1300 x 240mm* (15kg*)

Bottom Shelf - Base panel (3kg)

PC-6-H

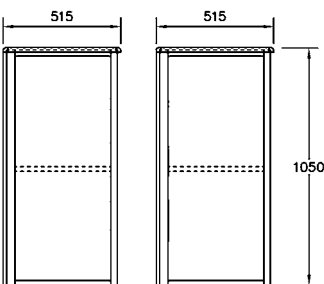

Zodiac counter 515 x 515 x 1050mm

Folded in a carton 1070 x 820 x 230mm (8kg)

Panel set - 1 x 2mm 709 x 997 2 x 3mm 416 x 997 (2kg)

Accessories: Nylon bag

Transport Case: 1160 x 980 x 300mm* (14.5kg*)

RANGE

2

Zodiac Counters

PC-1-L



PC-2-L



PC-6-L



PC-3



Sliding Lockable Doors



Transport Case



Nylon Bag



Specification

PC-1-L

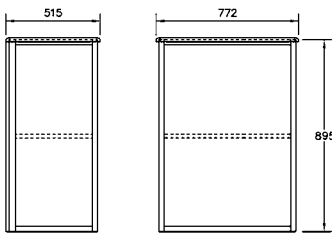

Zodiac counter 772 x 515 x 895mm (9kg)

Folded in a carton 1060 x 800 x 140mm (11kg)

3mm panel set 1 x 697 x 842 + 2 x 432 x 842mm (2kg)

Sliding door set in a carton 1100 x 750 x 60mm (5kg)

Accessories: Nylon bag
 Transport Case†: 1190 x 830 x 240*mm (12kg*)
 Bottom Shelf - Base panel (2kg)

PC-2-L

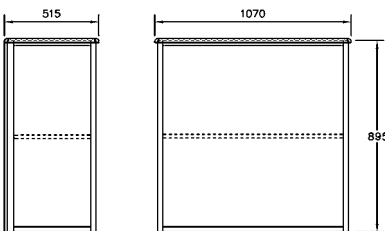

Zodiac counter 1070 x 515 x 895mm (11kg)

Folded in a carton 1100 x 1060 x 150mm (13.5kg)

3mm panel set 1 x 995 x 842 + 2 x 432 x 842mm (3kg)

Sliding door set in a carton 1100 x 750 x 60mm (7kg)

Accessories: Nylon bag
 Transport Case†: 1200 x 1300 x 240mm* (15kg*)
 Bottom Shelf - Base panel (3kg)

PC-6-L

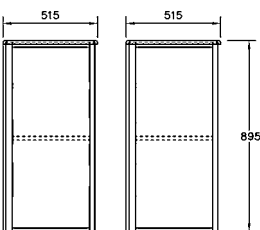

Zodiac counter 515 x 515 x 895mm (6kg)

Folded in a carton 1070 x 820 x 230mm (8kg)

2 + 3mm panel set - 2mm: 1 x 709 x 842 - 3mm: 2 x 416 x 842mm (2kg)

Accessories: Nylon bag (2kg)
 Transport Case†: 1160 x 980 x 300mm* (14.5kg*)

PC-3



Zodiac counter 1070 x 515 x 895mm + top box = 1103mm (15kg)

Folded in a carton 1100 x 1100 x 150mm (17kg)

3mm panel set 1 x 995 x 842 + 2 x 432 x 842mm
 and 1 x 985 x 157 + 2 x 205 x 157mm (4kg)

Sliding door set in a carton 1100 x 750 x 60mm (7kg)

Accessories: Nylon bag (2kg)
 Transport Case†: 1200 x 1300 x 240mm* (15kg*)
 Bottom Shelf - Base panel (3kg)

†Transport case depth increases from 240 to 300mm when sliding doors are included. *Approx size and weight.

RANGE

3

Zodiac Counters

PC-4-L or H



PC-9-L or H

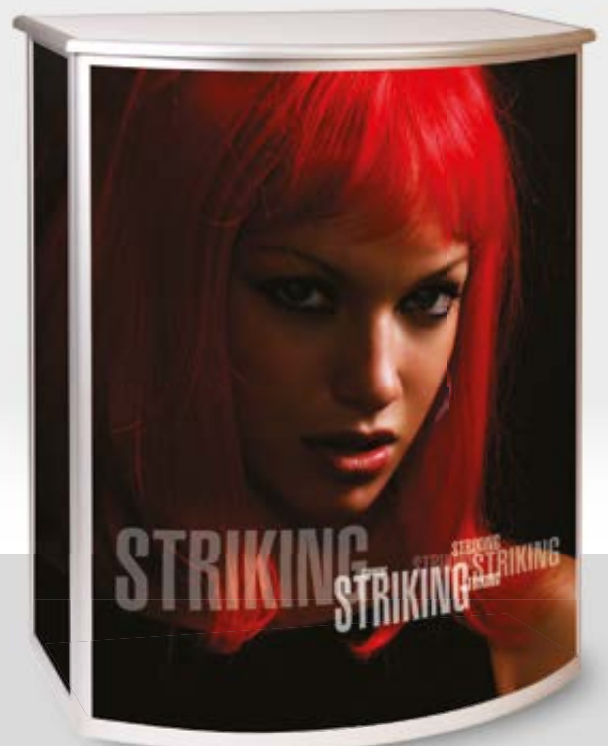

Sliding Lockable Doors



Transport Case



Nylon Bag



Specification

PC-4

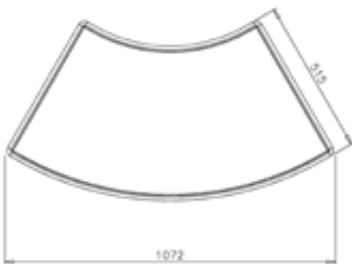

PC-4-L

Zodiac counter, curved 1072 x 515 x 895mm (10kg)

Folded in a carton 1060 x 1060 x 190mm (12kg)

2 + 3mm panel set 2mm: 1 x 1053 x 842mm

3mm: 2 x 432 x 842mm (3kg)

PC-4-H

Zodiac counter, curved 1072 x 515 x 1050mm (11kg)

Folded in a carton 1060 x 1060 x 190mm (15kg)

2 + 3mm panel set 2mm: 1 x 1053 x 997mm

3mm: 2 x 432 x 997mm (3kg)

PC-4 Accessories: Nylon bag

Transport Case†: 1280 x 1330 x 290mm* (16kg*)

PC-9

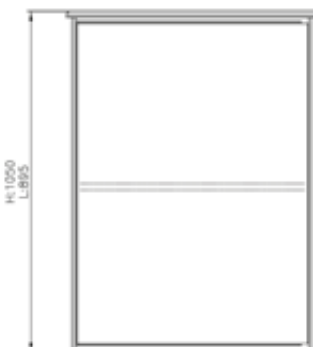
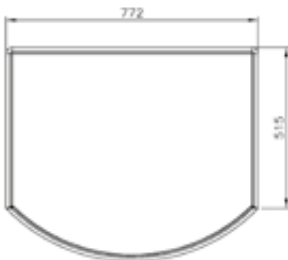

PC-9-L

Zodiac counter, curved front 772 x 658 x 895mm (11kg)

Folded in a carton 1060 x 840 x 230mm (13kg)

3mm panel set 1 x 788 x 842mm + 2 x 397 x 842 (2kg)

Sliding door set in a carton 1100 x 750 x 60 (3kg)

PC-9-H

Zodiac counter, curved front 772 x 658 x 1050mm (10.5kg)

Folded in a carton 1060 x 840 x 230mm (13kg)

3mm panel set 1 x 778 x 997mm + 2 x 397 x 998 (2kg)

Sliding door set in a carton 1100 x 750 x 60 (3kg)

PC-9 Accessories: Nylon bag

Transport Case: 1160 x 980 x 300mm* (14.5kg*)

Bottom Shelf - Base panel (2kg)

†Transport case depth increases from 240 to 300mm when sliding doors are included. *Approx size and weight.

RANGE

4

Zodiac Counters

PC-12-H-UK



PC-12-B-UK



PC-12-C-UK



890 & 890P



Easy construction



Transport Case



Specification

PC-12-H-UK

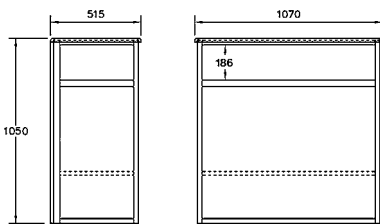

Zodiac showcase 1070 x 515 x 1050mm (32kg*) c/w:

- | | |
|--|--|
| <ul style="list-style-type: none"> • Acrylic top • Display shelf • Aluminium storage shelf • Aluminium bottom shelf • Locking sliding doors | <ul style="list-style-type: none"> • Fitted with 3mm clear acrylic & white foam panels <p>3mm panel set size:</p> <ul style="list-style-type: none"> • Acrylic: 1 x 996 x 200 + 2 x 433 x 200mm • White foam: 1 x 996 x 778 + 2 x 433 x 788mm |
|--|--|

PC-12-B-UK

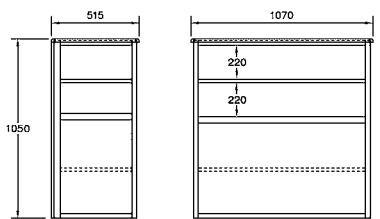

Zodiac showcase 1070 x 515 x 1050mm (40kg*) c/w:

- | | |
|--|---|
| <ul style="list-style-type: none"> • Acrylic top • Acrylic display shelf • Display shelf • Storage shelf • Bottom shelf | <ul style="list-style-type: none"> • Locking sliding doors • Fitted with 3mm clear acrylic & white foam panels <p>3mm panel set size:</p> <ul style="list-style-type: none"> • Acrylic: 1 x 996 x 489 + 4 x 433 x 234mm • White foam: 1 x 996 x 489 + 2 x 433 x 489mm |
|--|---|

PC-12-C-UK

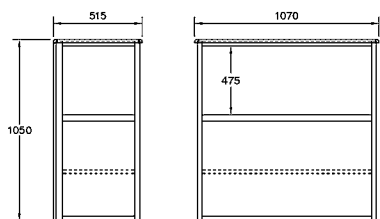

Zodiac showcase 1070 x 515 x 1050mm (38kg*) c/w:

- | | |
|--|--|
| <ul style="list-style-type: none"> • Acrylic top • Display shelf • Aluminium storage shelf • Aluminium bottom shelf • Locking sliding doors | <ul style="list-style-type: none"> • Fitted with 3mm clear acrylic & white foam panels <p>3mm panel set size:</p> <ul style="list-style-type: none"> • Acrylic: 1 x 996 x 489 + 2 x 433 x 489mm • White foam: 1 x 996 x 489 + 2 x 433 x 489mm |
|--|--|

890 half glazed & 890-P fully glazed

Zodiac tower 468 x 468 x 1980mm (30kg*) c/w:

- | | |
|--|---|
| <ul style="list-style-type: none"> • 5mm clear acrylic shelves • Locking sliding doors | <ul style="list-style-type: none"> • Clear acrylic & white foam panels • Down light |
|--|---|

Transport cases

PC-12-TRP and 890-TRP: 1200 x 1300 x 240mm (15kg)*

RANGE

5

Zodiac Plinths



PD-200

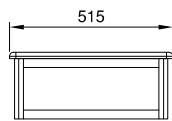
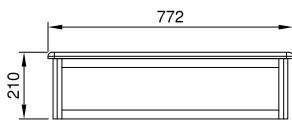

Zodiac plinth 772 x 515 x 210mm

Folded in a carton 1060 x 800 x 130mm (7kg)

3mm panel set F: 698 x 157 B: 704 x 180mm S: 2x 433 x 157 (2.5kg)

Accessories: Nylon bag

PD-400

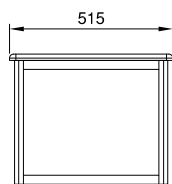
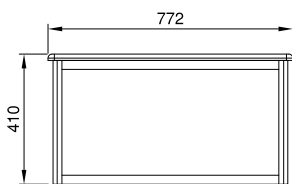

Zodiac plinth 772 x 515 x 410mm

Folded in a carton 1060 x 800 x 130mm (8kg)

3mm panel set F: 698 x 357 B: 704 x 380mm S: 2x 433 x 357 (2.5kg)

Accessories: Nylon bag

PD-800

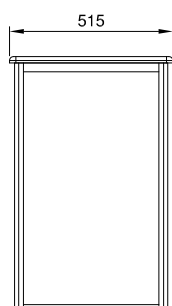
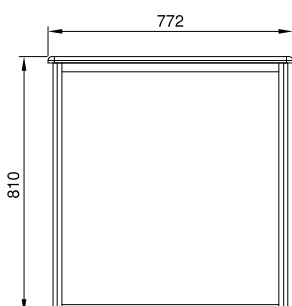

Zodiac plinth 772 x 515 x 810mm

Folded in a carton 1060 x 800 x 130mm (9kg)

3mm panel set F: 698 x 757 B: 704 x 780mm S: 2x 433 x 757 (2.5kg)

Accessories: Nylon bag

Perfectly flexible

Modular Portable Furniture

Zodiac Counters and Showcases

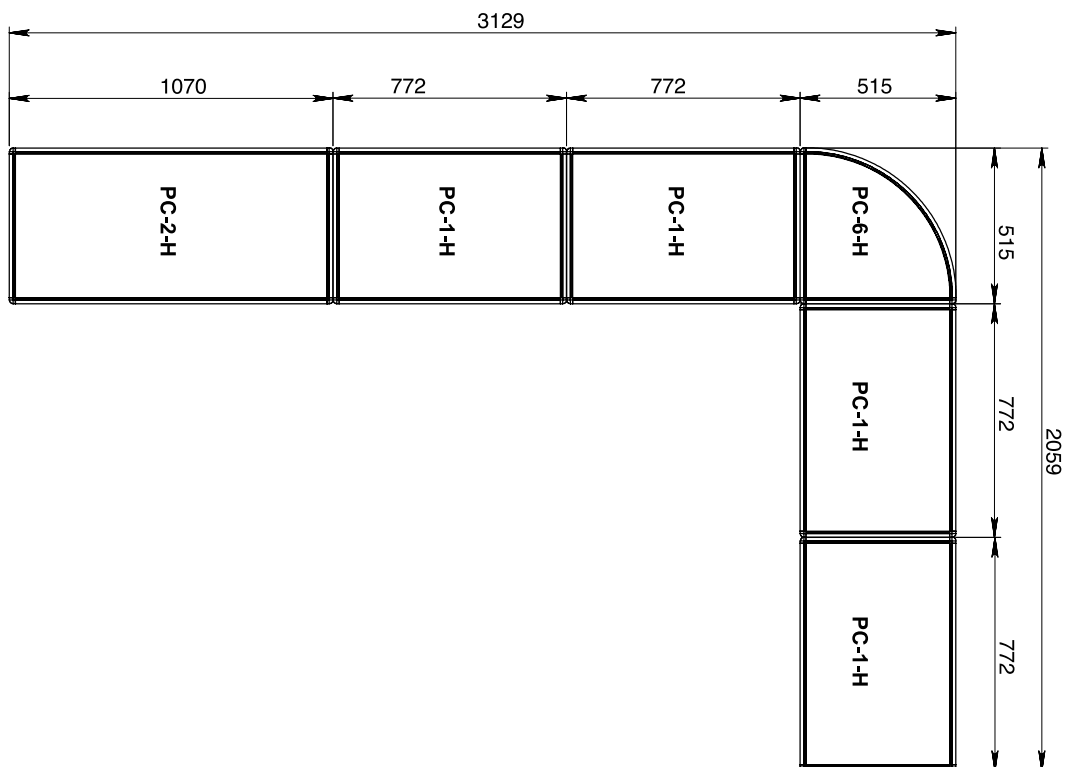
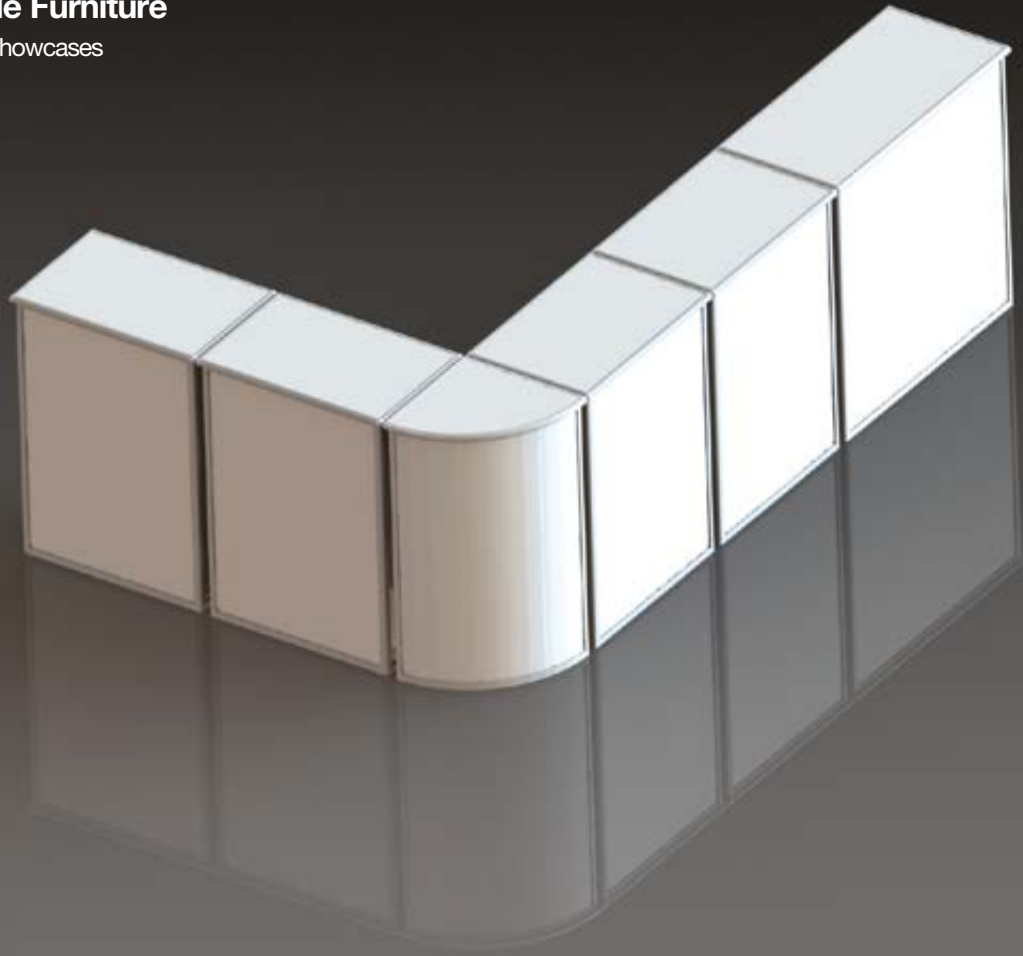

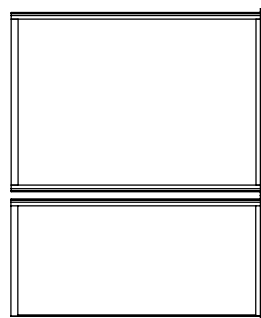
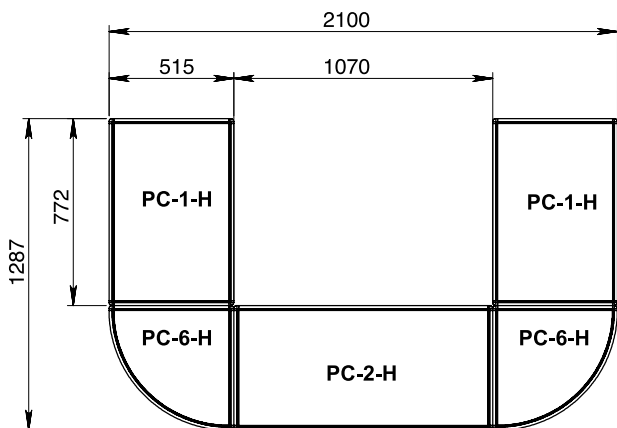
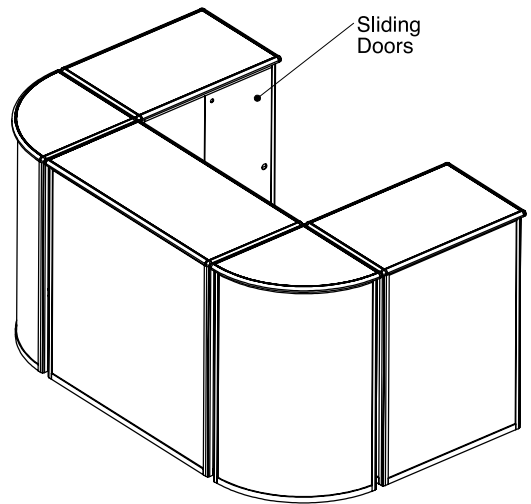
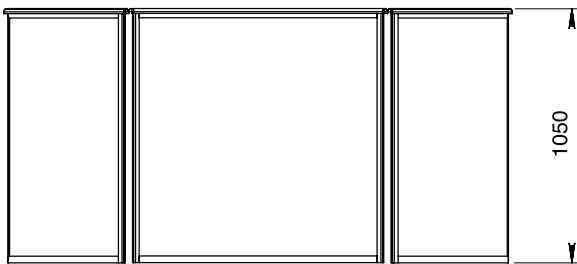
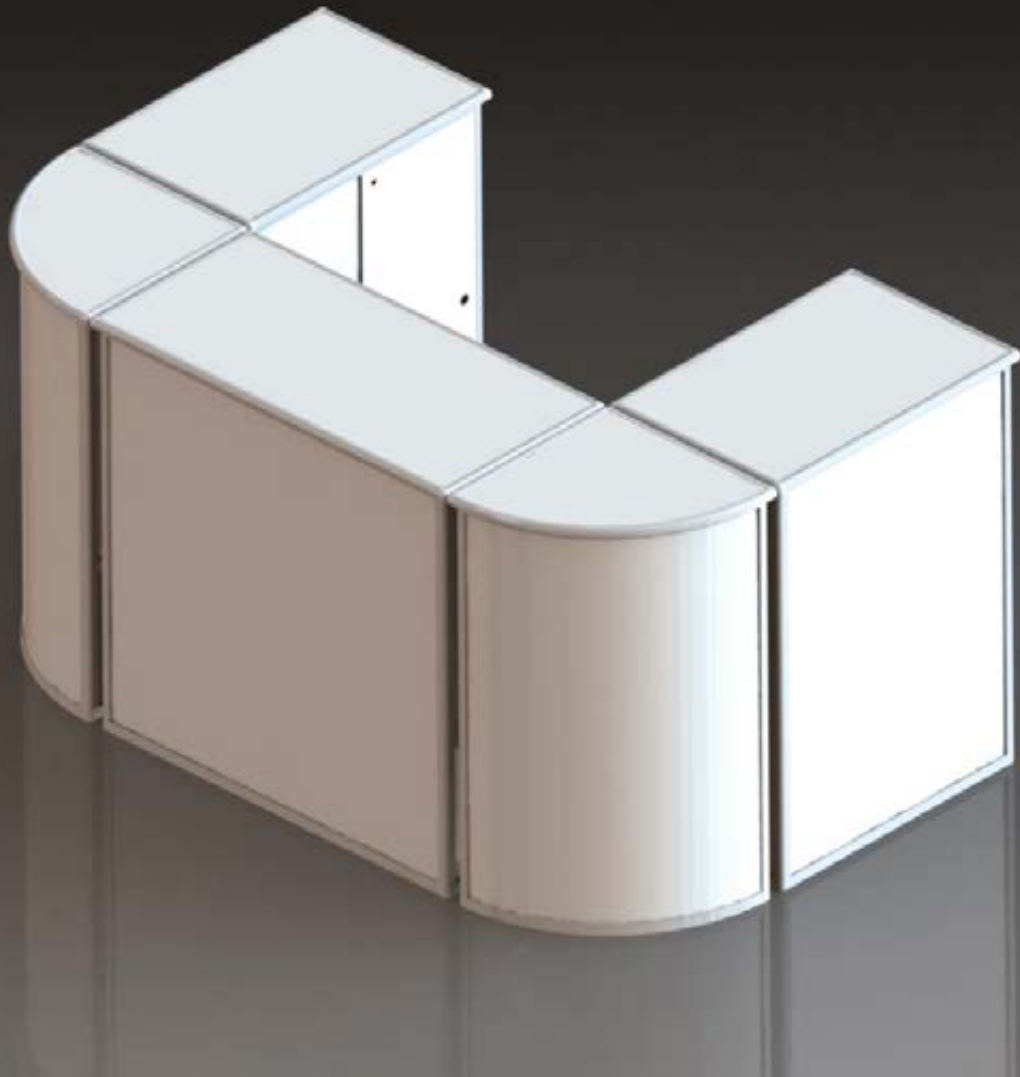

Perfectly flexible

Modular Portable Furniture

Zodiac Counters and Showcases

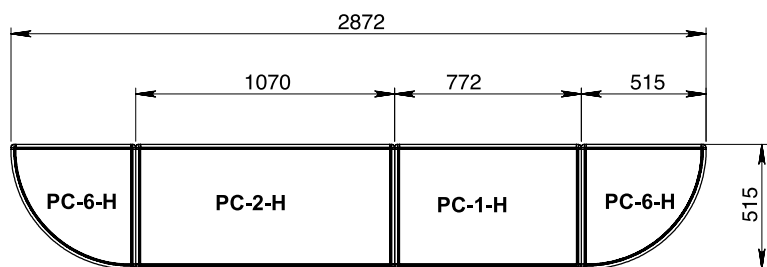
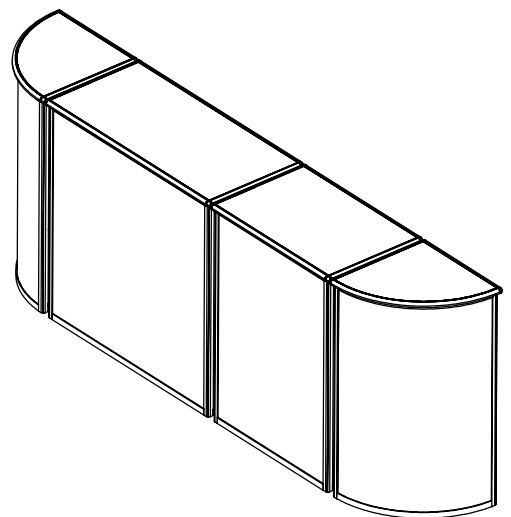
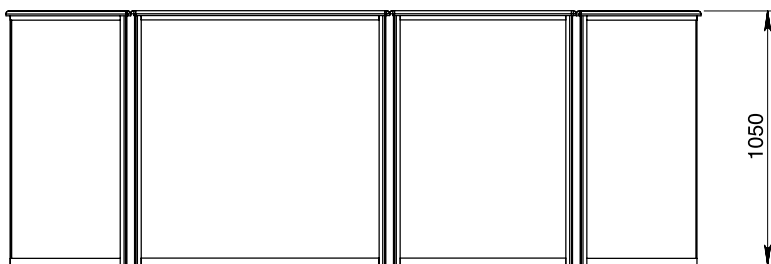
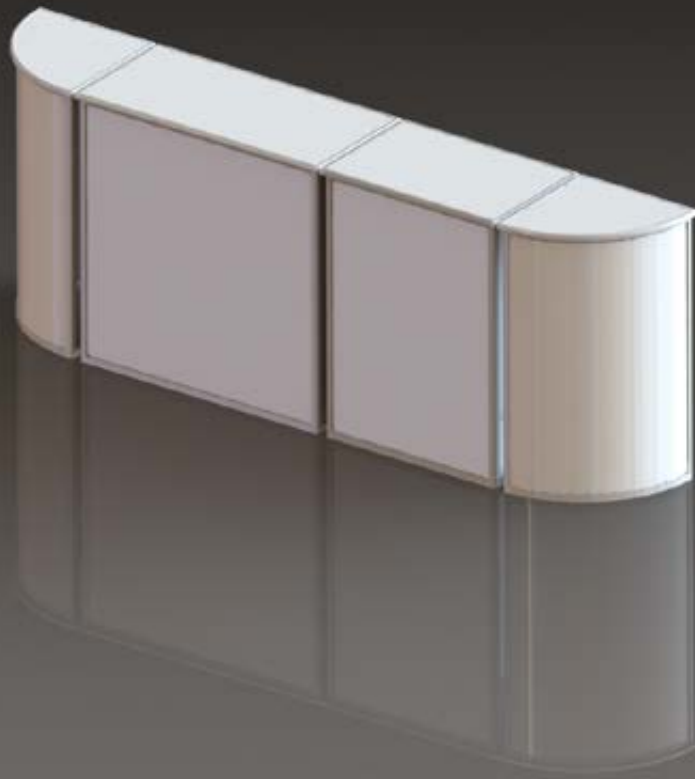

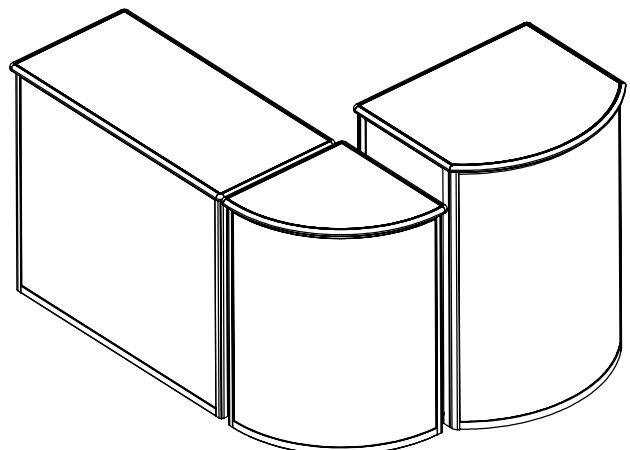
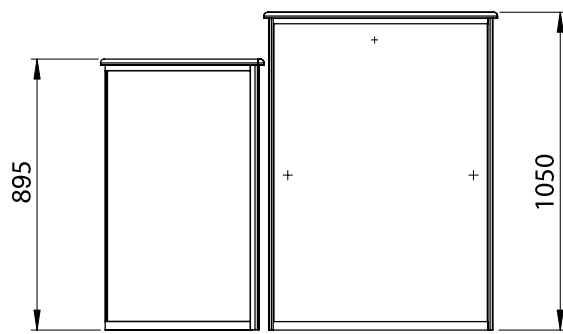
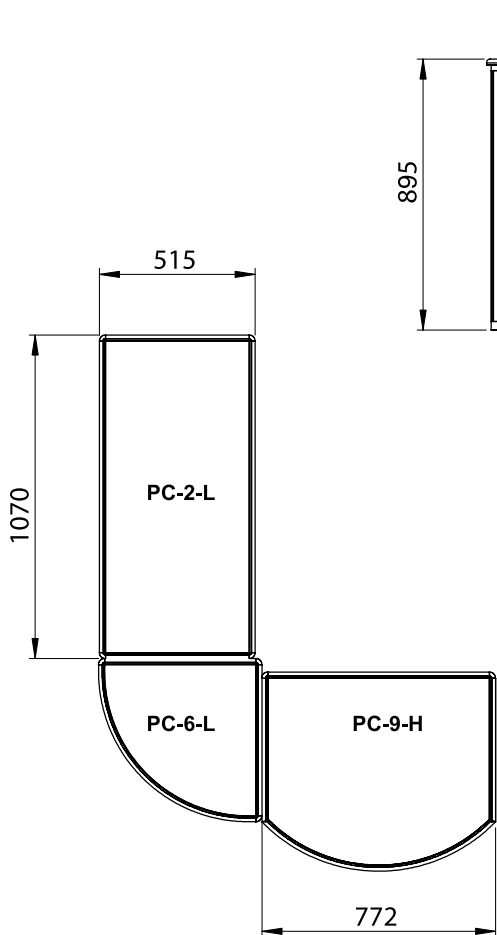
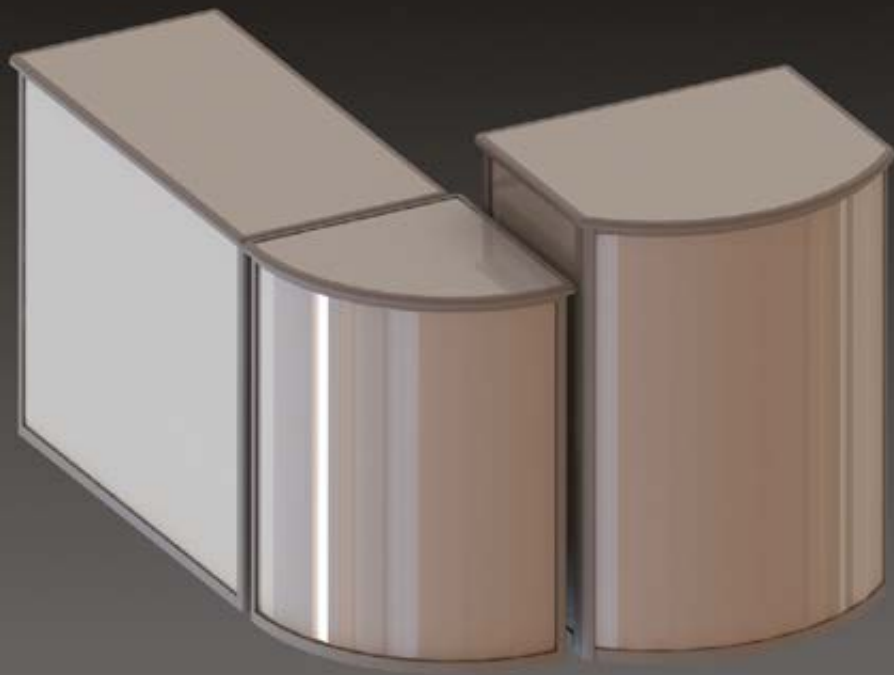

Perfectly flexible

Modular Portable Furniture

Zodiac Counters and Showcases

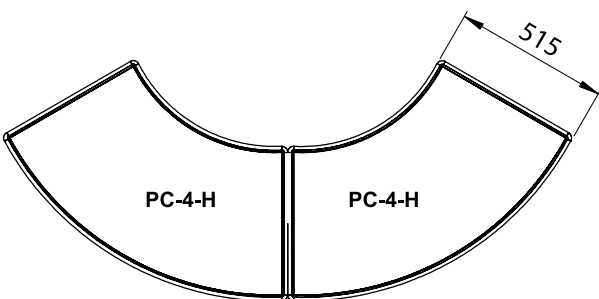
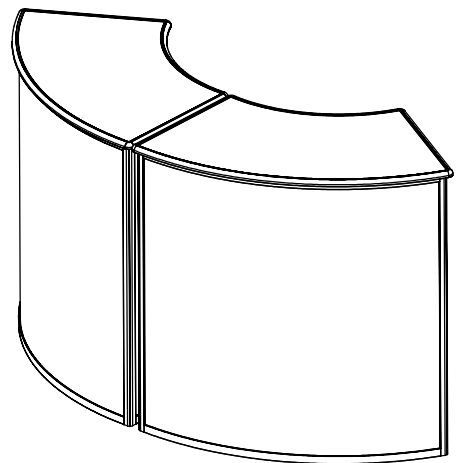
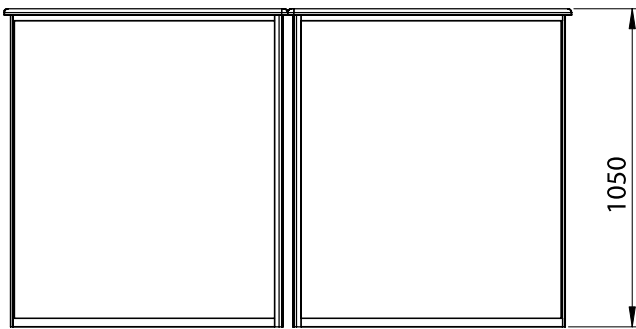
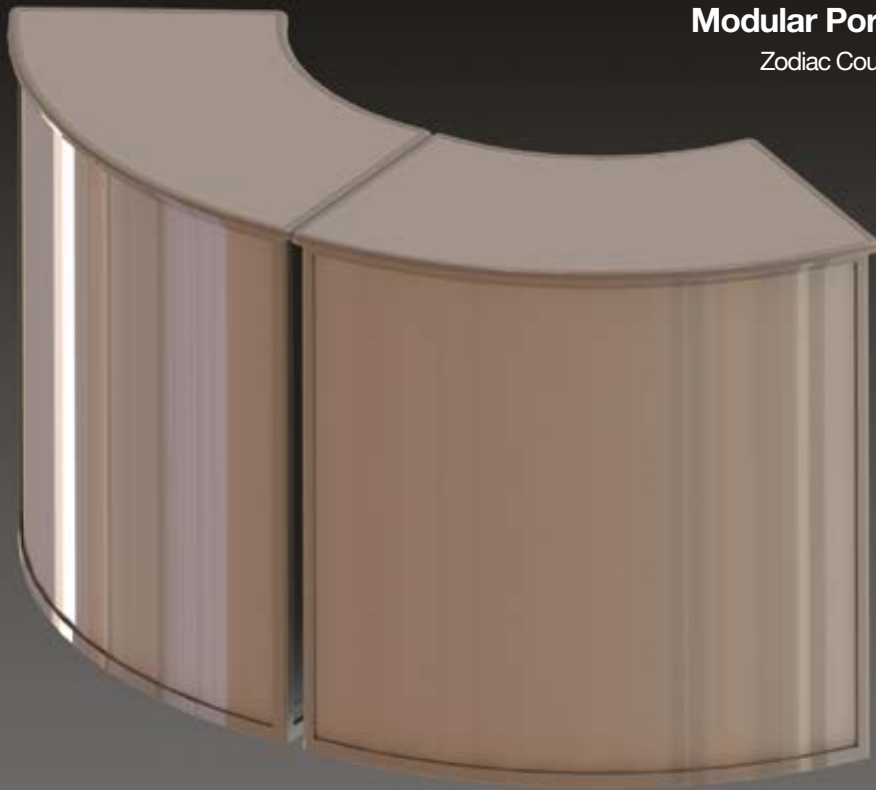

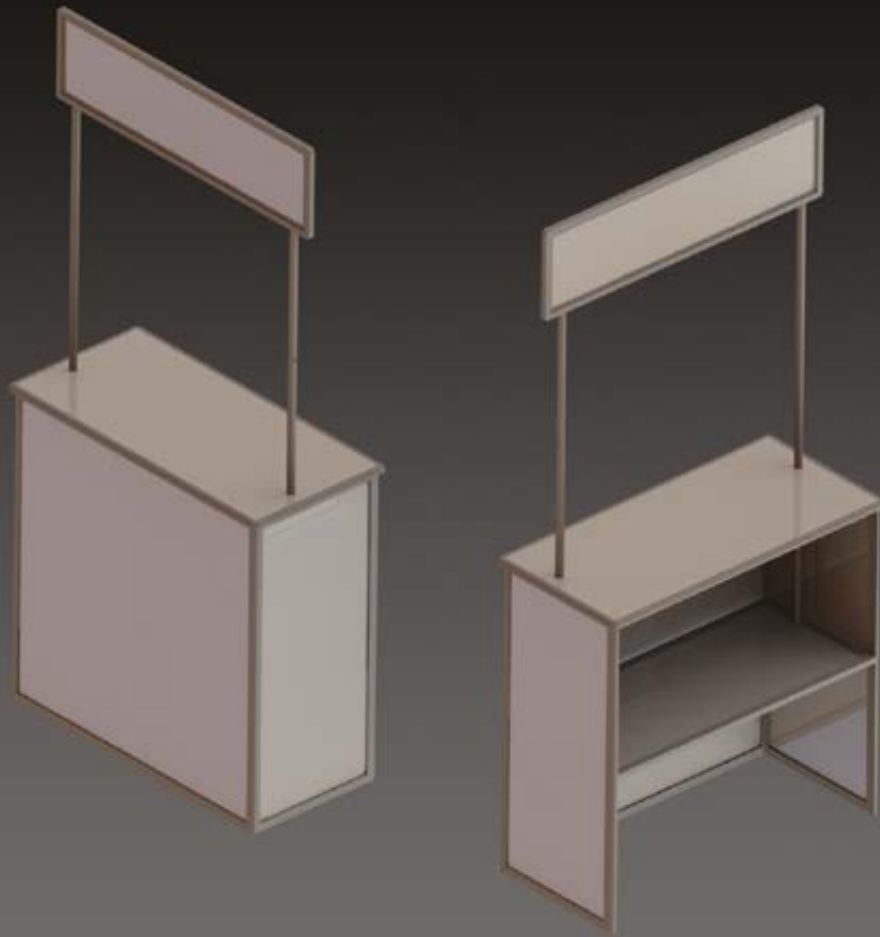

Folding counters including Top Signs

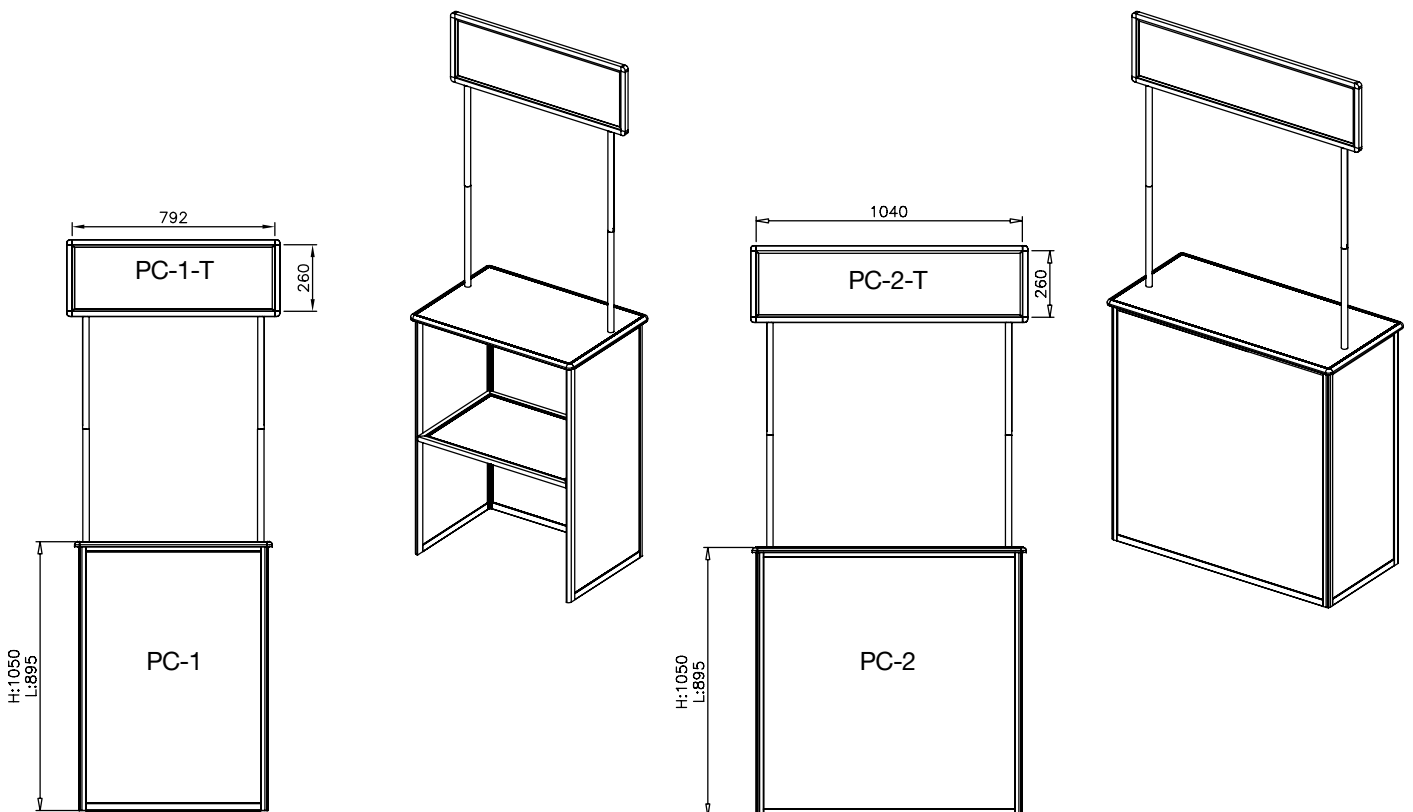

Perfectly flexible

Modular Portable Furniture

Zodiac Counters and Showcases



Folding counters including Snap Frames.
Various sizes and formats available.

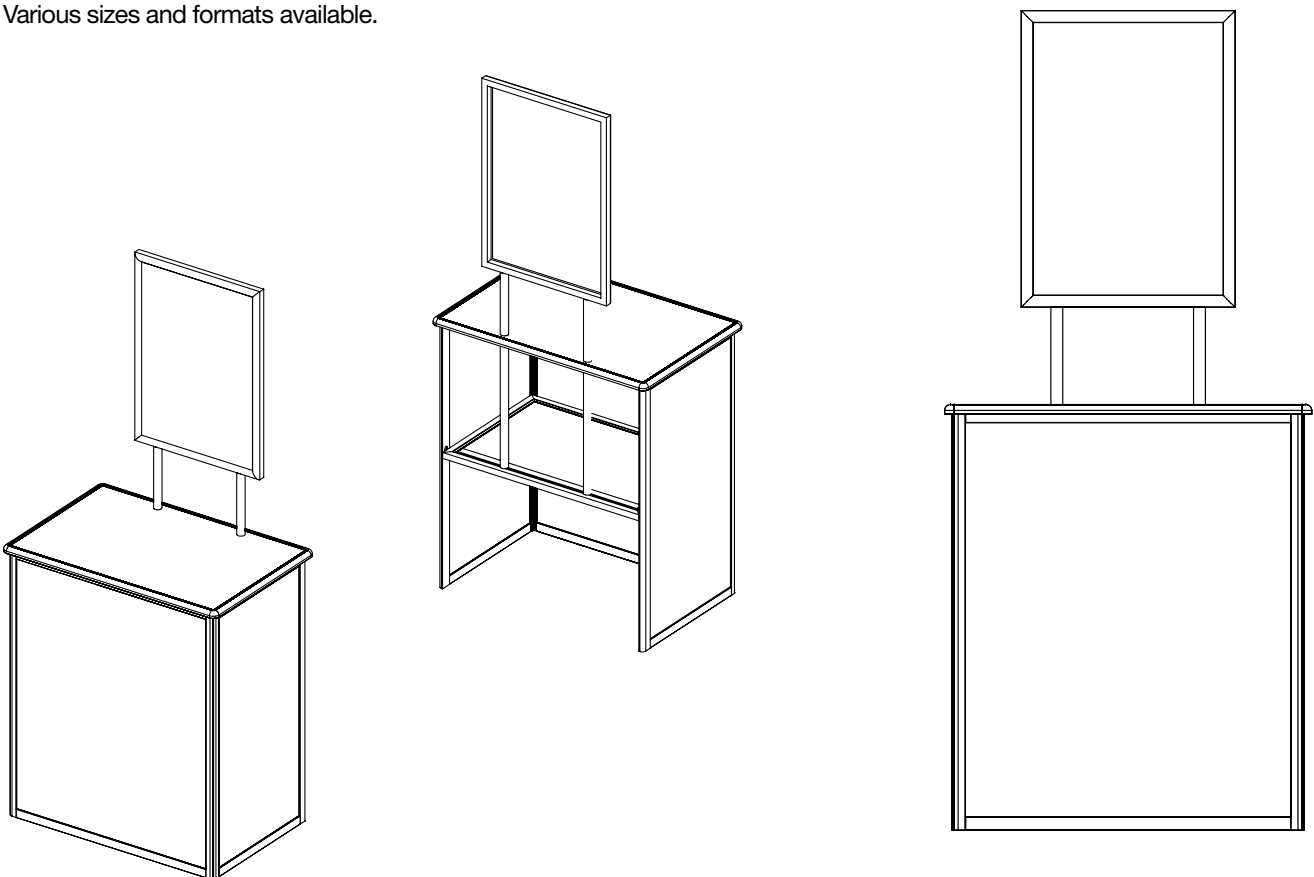

Portable Zodiac Furniture

Perfectly simple

**A range of modular counters
all 515mm deep with two
stock heights 895 & 1050mm.**

**Available in rectangular
and curved formats.**

**Special sizes and
specification can be
supplied.**

