

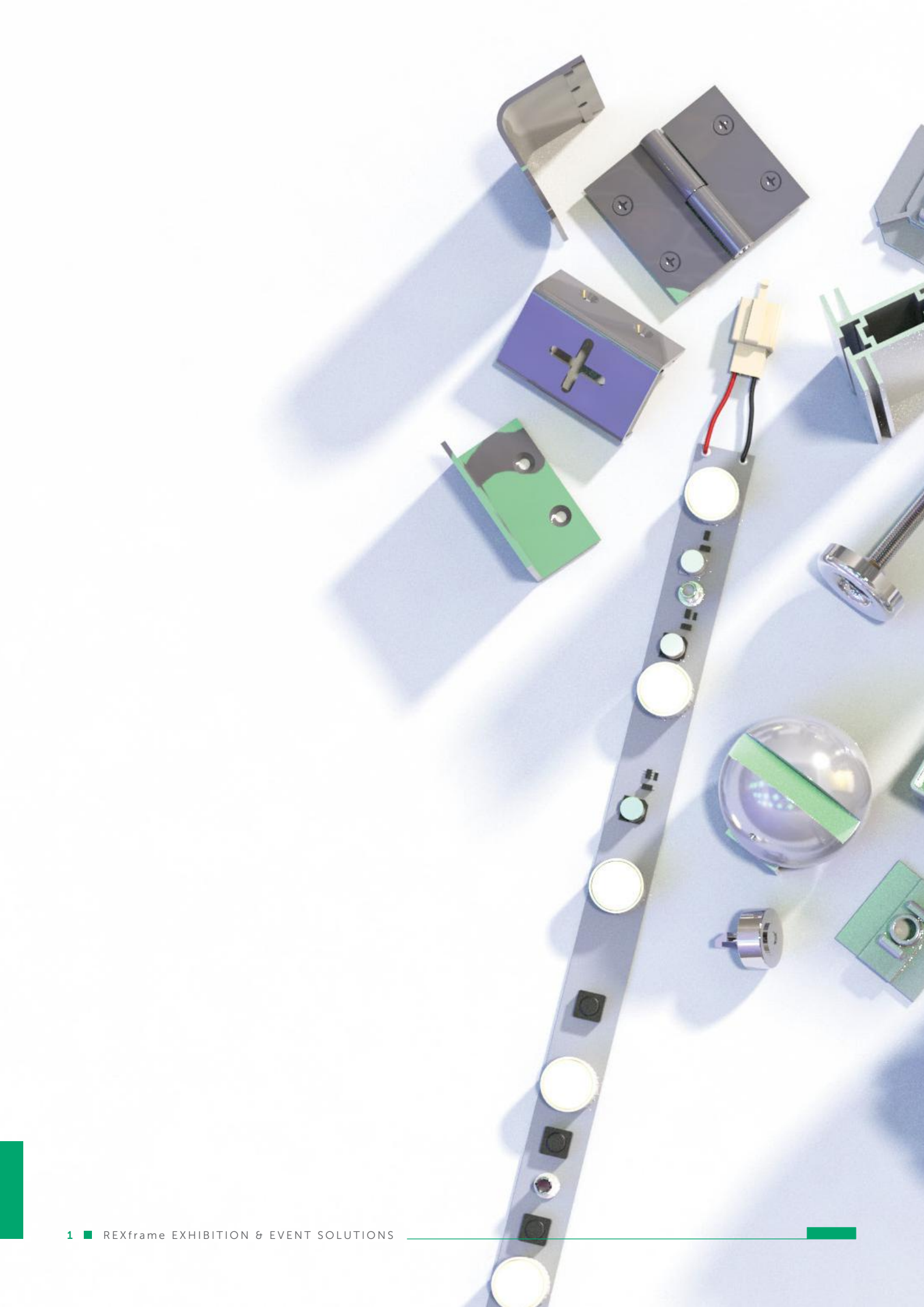

Exhibition & Event Solutions

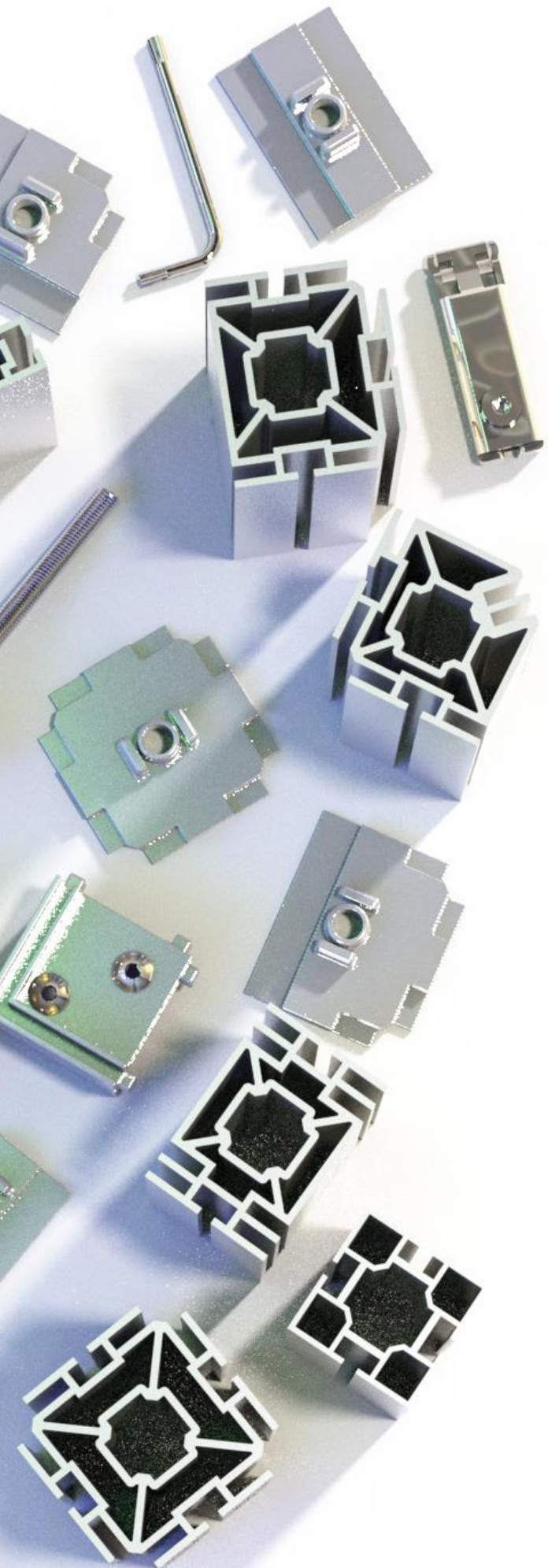



Contents

3 - 10 / REXwall

11 - 12 / REXframe Lightboxes

13 - 14 / REXframe D'LiTe Range

15 - 16 / REXframe Universal
Retro Range

17 - 22 / REXframe Product List

23 - 24 / REXframe Gallery



REXwall fabric archway

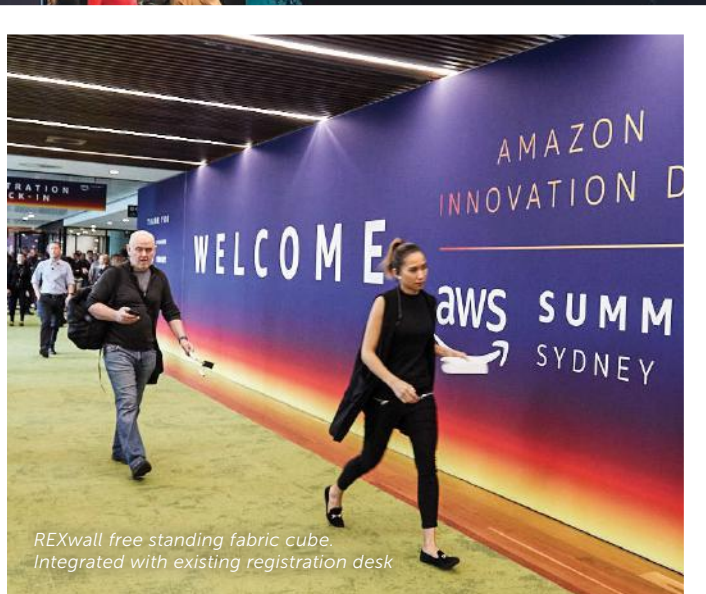

REXwall free standing fabric cube.
Integrated with existing registration desk

The REXwall System is a simple way to create booths and partitions, specifically aimed at the end user, it is designed exclusively to suit fabric finished with a silicon edge gasket (SEG). The simple locking system allows frames to be put together quickly and easily, with no experience and just one lock key.

The select range of profiles and accessories is all that is needed to create an impactful space in little time. Ideal for exhibition booths, hanging shapes, large free standing structures, cubes, lightboxes and much more, the REXwall system allows you to push the boundaries like never before.

The functionality of this range is second to none, all pieces can be 'modularized', and used time and time again in any environment. Shelving, windows, doors, TV supports & lighting can be added, making the REXwall range the most versatile fabric solution on the market.

REXwall Introduction



REXwall fabric archways & various structures



REXwall fabric archway & cubes. Archway dimensions: 65' x 17'

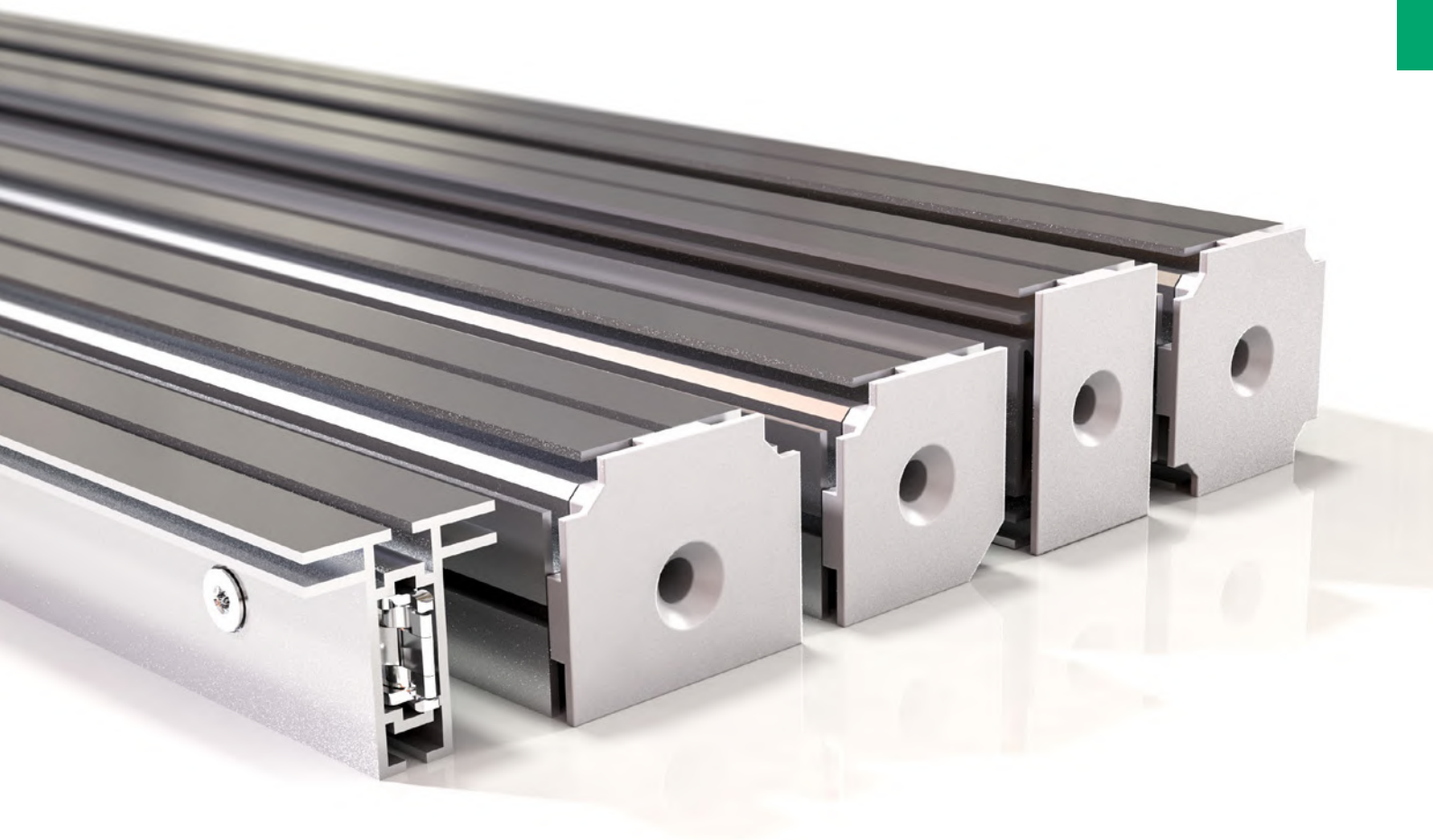

At the centre of the REXwall system is the RX-105 Double Sided Profile, being one of the most versatile profiles in the range, it is now being utilized like never before.

The RX-105 rails are simply locked in to any of the REXwall posts, allowing cubes, partitions and large walls to be erected quickly and easily. The versatility of the system is second to none, using standardized sizes the RX-105 rails can be adapted to any build and easily connected to create dynamic displays.

The REXwall RX-127 Corner Post is ideal for connecting two faces. This profile allows for a 90° change in direction whilst maintaining a constant channel for

SEG finished fabric. The post neatly houses fabric corners, resulting in a tight, seamless face.

The REXwall RX-126 Tri Post is the next step in creating intricacy. This profile enables segmentation, offering a three way join that allows users more varied customisation possibilities. SEG channels allow for all fabrics to be managed accordingly.

The adaptability of the REXwall RX-117 Post is unparalleled. This profile allows for the connection of up to four faces, in four directions, allowing for the most customisation of all the posts.

The endless creative possibilities clearly set the REXwall system above the rest.

REXwall Profiles



REXwall fabric archway with ceiling, integrated with existing bulkhead

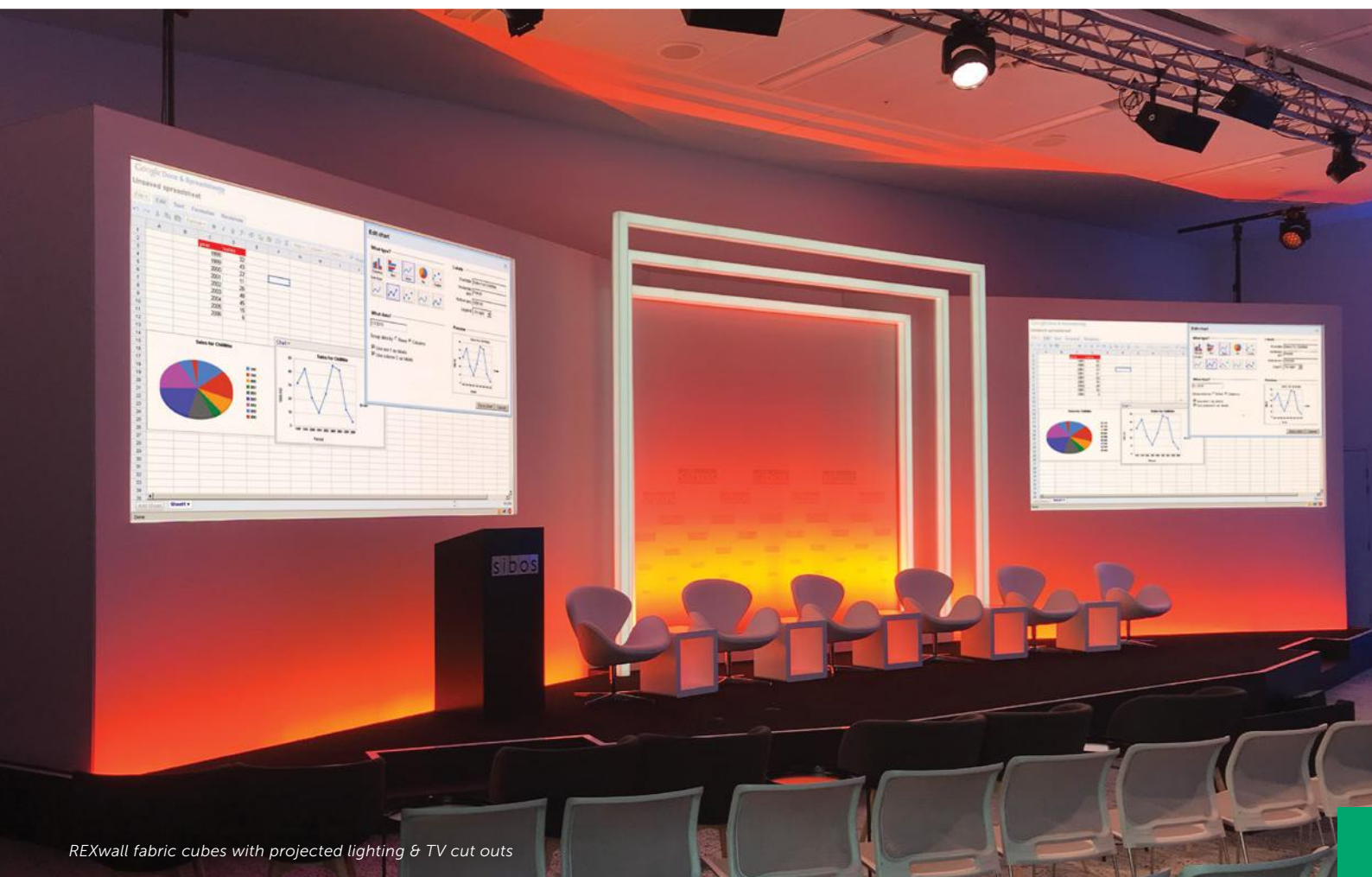

REXwall fabric cubes with projected lighting & TV cut outs



REXwall accessories play a large role in the endless capabilities of the REXwall system. From shelving, to lighting, to mounting, every customisation need and want can be accomplished through the use of one of our many attachments.

The REXwall RX-212 90° lock is an essential accessory to all frame plans. It enables the connection of one profile to another with one simple twist. One tool fits all and the RX-212 fits the majority of situations making it a key accessory to have on hand.

Stand-alone frames are space-conscious, sleek and effective. These frames are made possible with the REXframe RX-232 105 Corner Knuckle. This knuckle connects two pieces of RX-105 rail at a 90° angle with RX-212 locks, whilst maintaining the SEG channel. Simple, compact, efficient.

Lightboxes are a great way to boost the impact and reception of your signage. The REXframe RX-110 Double Sided Lightbox profile has an internal groove that houses our lighting system, illuminating fabrics displayed on both the front and back. The REXframe RX-301 5-Light Module has been tested and refined to achieve perfect light scatter, resulting in a crisp, bright final product.

REXwall Accessories

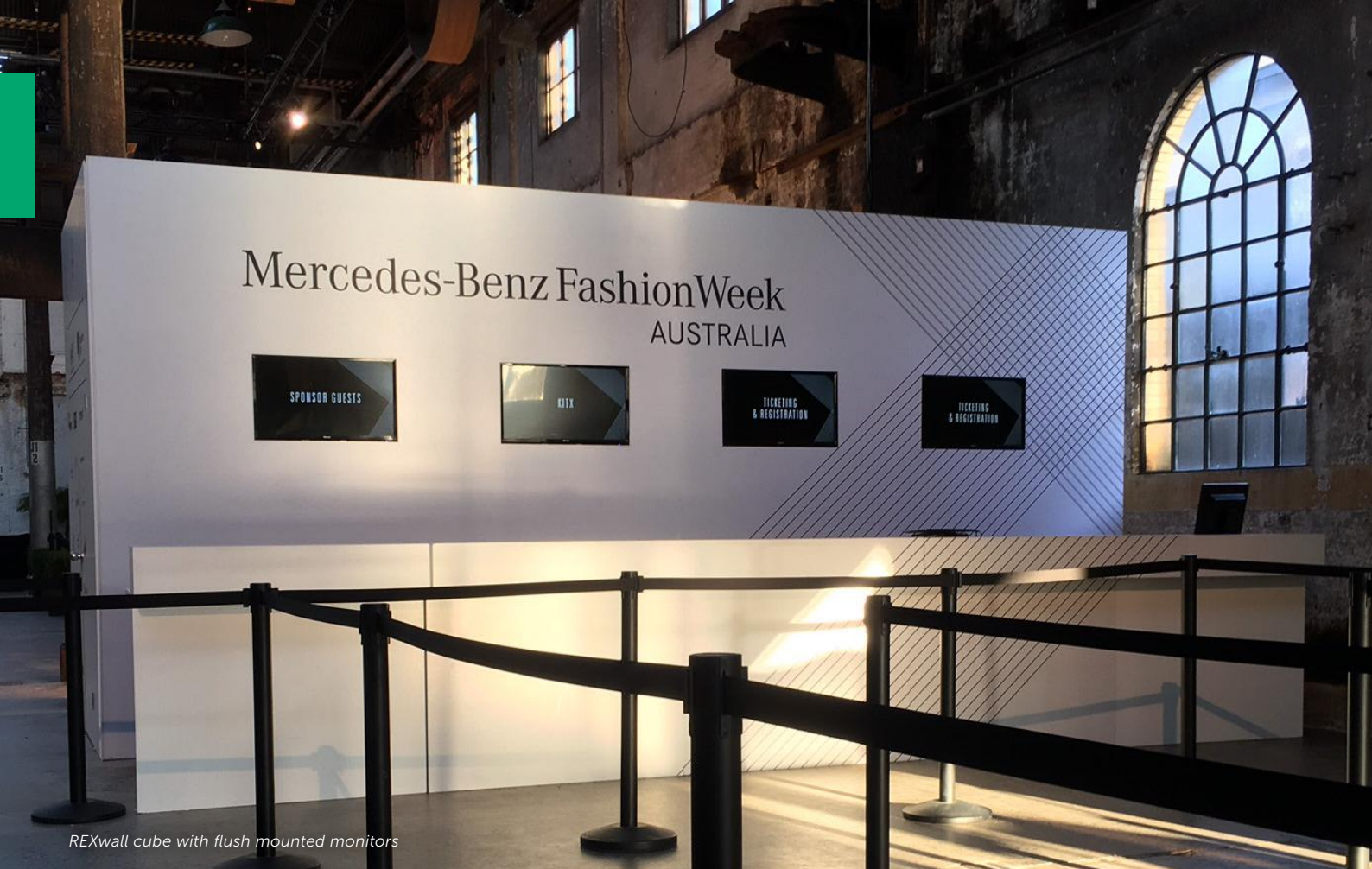

REXwall cube with flush mounted monitors



REXwall fabric stand with integrated door

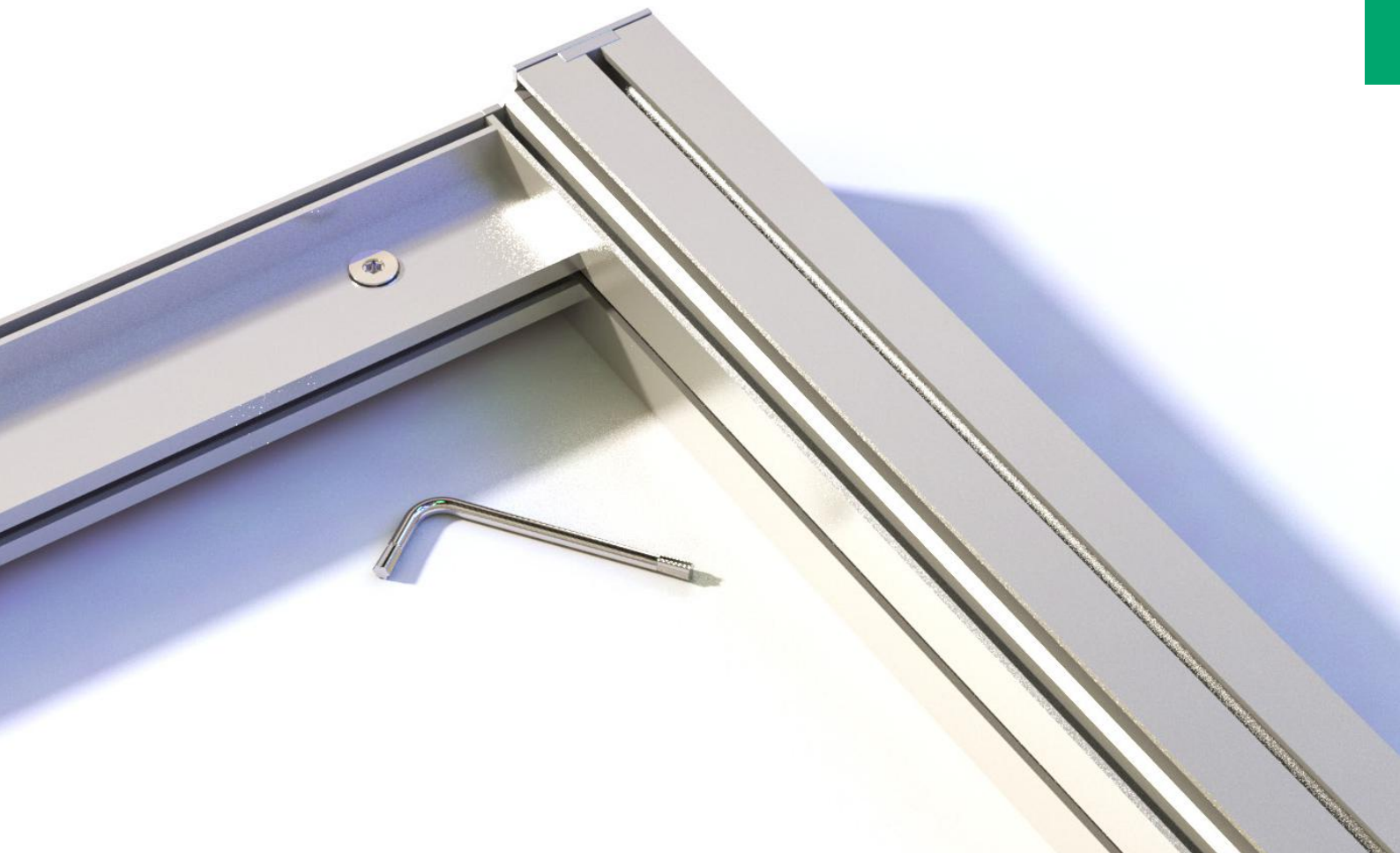

A lock key is the only tool needed to construct REXwall. The versatility and simplicity of the profiles lets you create large, impactful environments in a fraction of the time, with no prior experience.

The REXwall range is broken into two categories:
Rails & Posts

The REXwall posts are designed to create a strong foundation for any construction, the builds are structurally sound with little support or bracing needed. All posts are interchangeable, allowing any

structure to be altered with ease.

The adaptability of REXwall rails allows you to create any space imaginable, the simple connection system means structures and sizes can be altered at the last minute with no need for additional fabrication.

REXwall creates a world of possibilities.

REXwall Construction

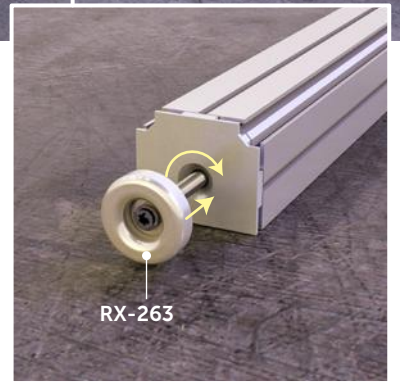
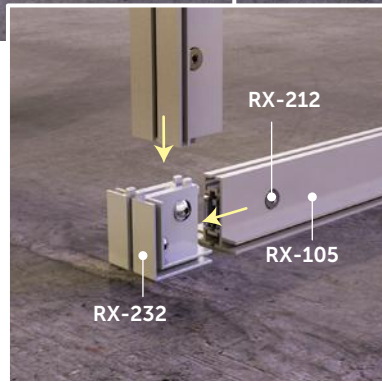
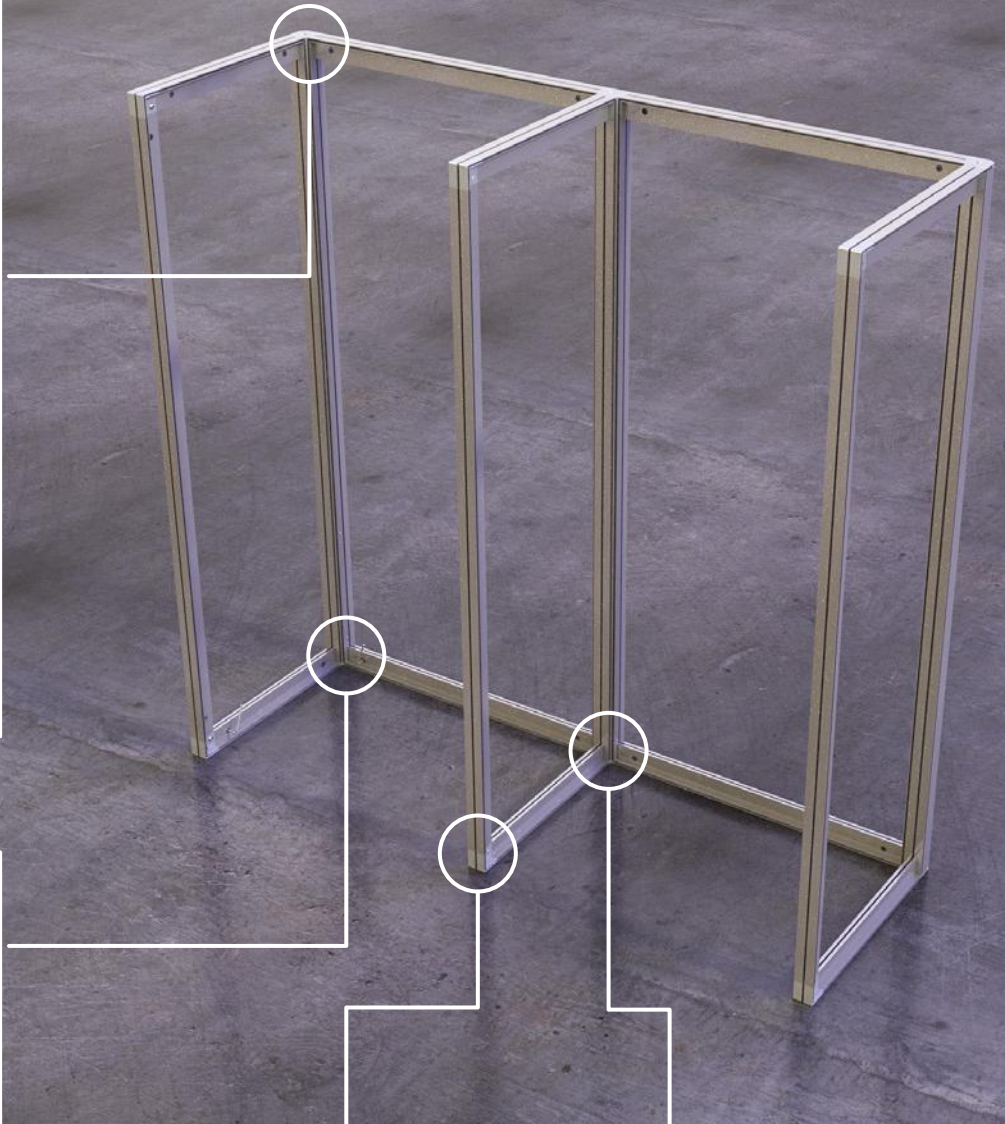
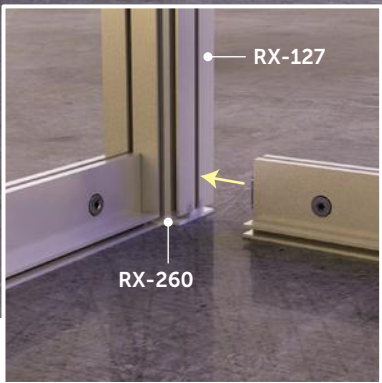
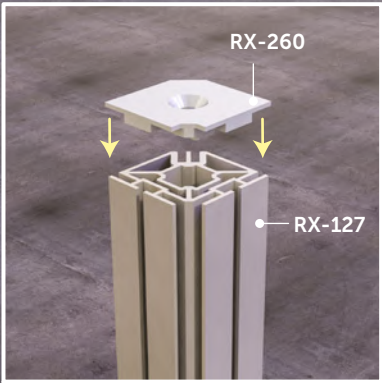

*Adjustable feet can be added for any uneven surfaces.



The REXframe Lightbox profiles use low voltage LED lighting and create a beautiful, eye catching effect at any exhibition environment.

The LED lighting provides bright, even illumination with long life and low power consumption, LED lights are the smart lighting choice, giving better results at a fraction of the energy cost. The 24 volt LED modules simply clip into the frame and are easily removed when dismantling. As with all REXframe systems, the print can be easily changed to match the season, event or promotion.

Available in double sided, single sided, slim line and the ADA compliant D'LiTe option, it has never been easier to create lightboxes.

All REXframe lightbox profiles can utilize the Edge lit or the LaddeREX System, creating more diversity & control than ever before. Lightboxes can be dimmed to create a more subtle effect, or displayed with movement and vibrant colours via the RGB modules.

The Light Box is brilliant and brightens up any space simply and tastefully.

REXframe Lightboxes



REXframe curved hanging fabric lightbox



REXframe illuminated fabric cubes

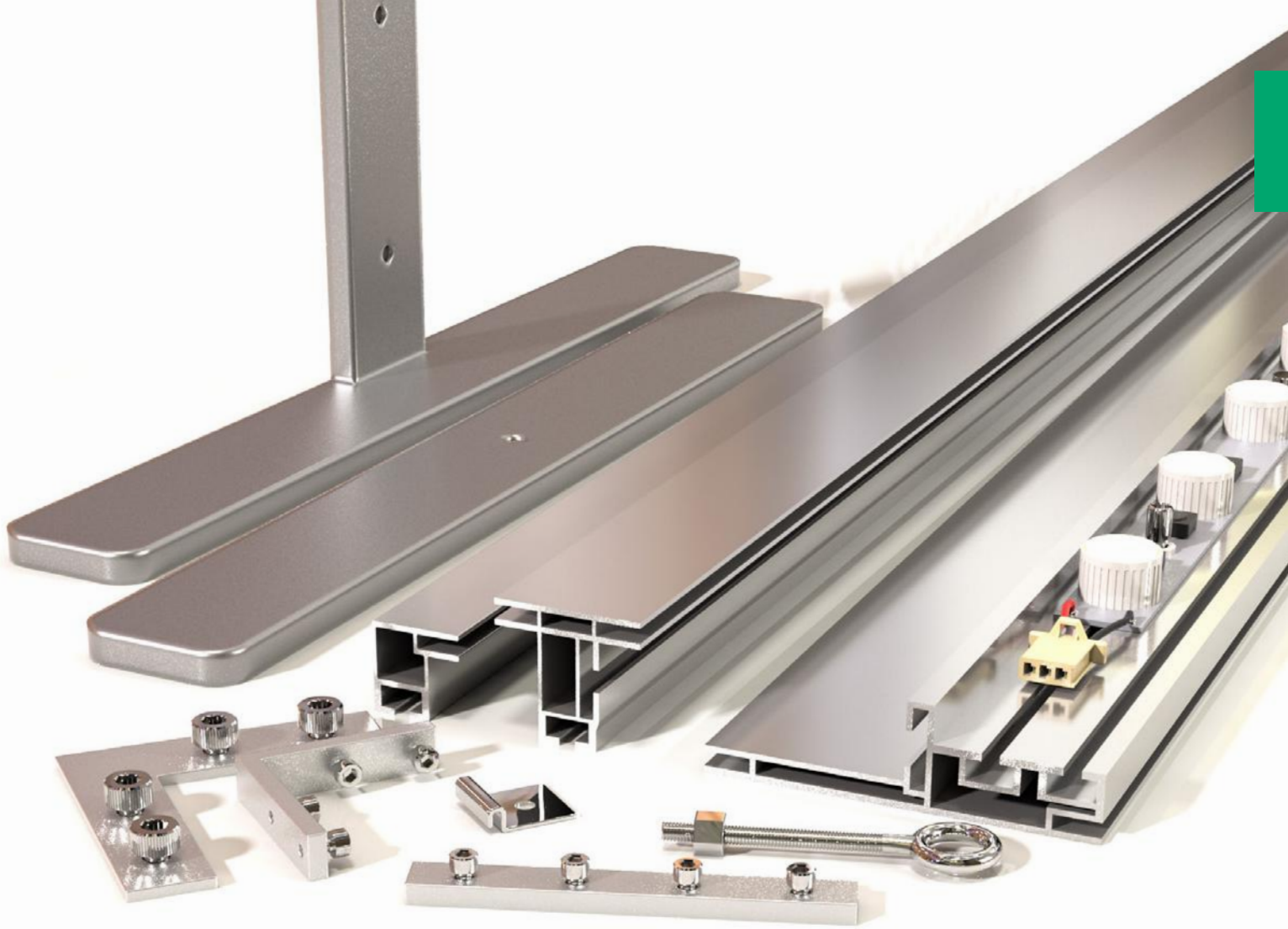

Free standing, suspended and wall mounted, the D'LiTe REXframe profiles are a lighter, more cost effective option. Perfect for media walls, stage backdrops, petitioning a room, directional or promotional signage, these profiles are a great solution for exhibition spaces with high traffic.

The free standing Double Sided D'LiTe REXframe (RX-119) has two sturdy feet to provide the required stability for any event, it is quick to assemble and can be easily dismantled and stored.

The Single Sided D'LiTe (RX-118) is lightweight, compact and cost effective. It is perfect for wall mounting and can be utilized on existing systems

At under 4" wide, the ADA compliant Wall Mount Lightbox D'LiTe (RX-120) is perfect for adding the 'WOW' factor, using the Edge lit or LaddeREX System this profile is simple to put together and can brighten up any space.

Offering "more bang for your buck", the D'LiTe options make it easier than ever before to create a high impact space at a fraction of the cost.

REXframe D'LiTe Range



REXframe Slim Lightbox Inset into wall



REXframe curved free standing media wall

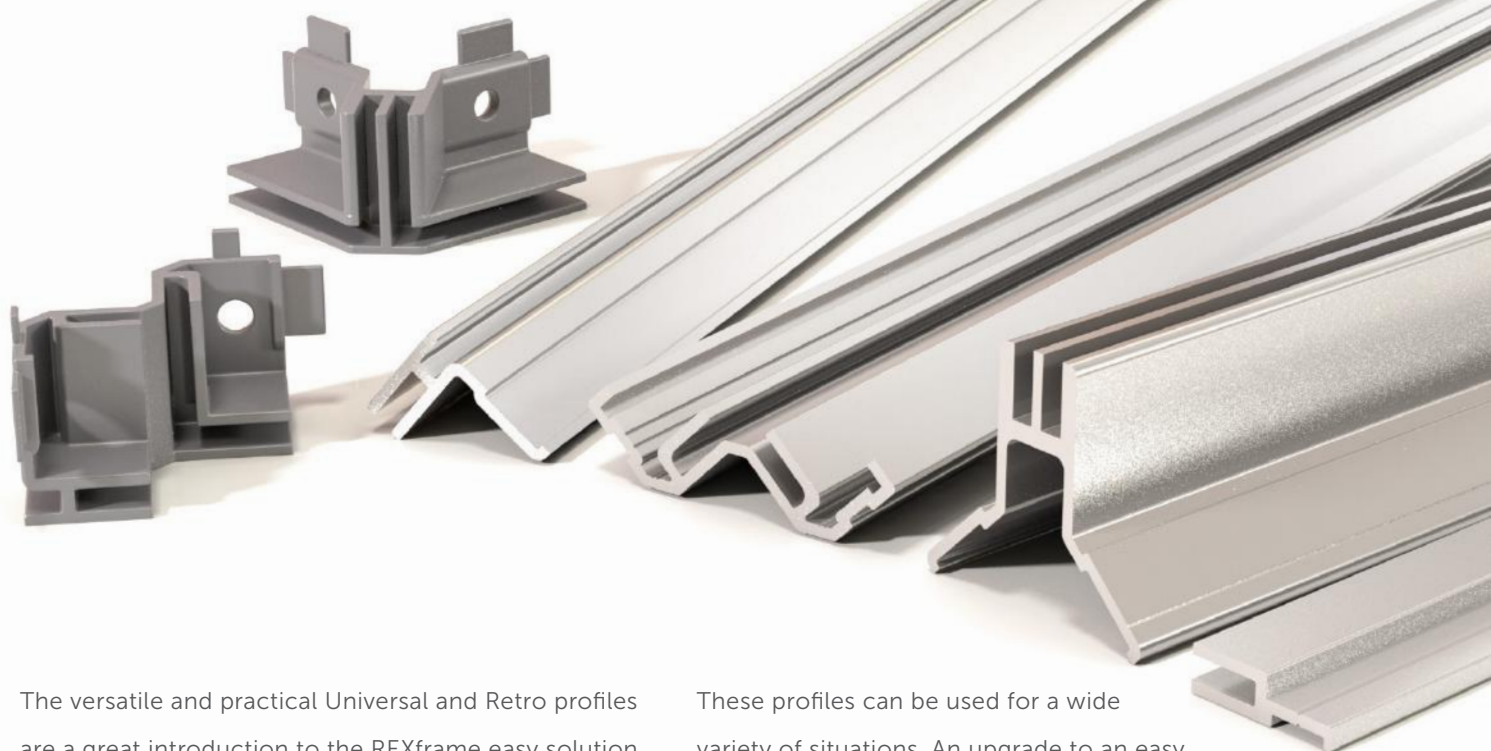

The versatile and practical Universal and Retro profiles are a great introduction to the REXframe easy solution system.

Simply screw onto an existing surface, inside a cavity or onto an existing light box frame to convert traditional printing into a fabric graphic alternative.

These profiles can be used for a wide variety of situations. An upgrade to an easy and cost effectively option, offering a whole new look.

Quick, tool free fabric graphic changes in seconds.

REXframe Universal Retro Range



REXframe Universal fixed to existing boardroom with TV cut out



REXframe Universal fixed to large outdoor marquee

REXframe Profiles

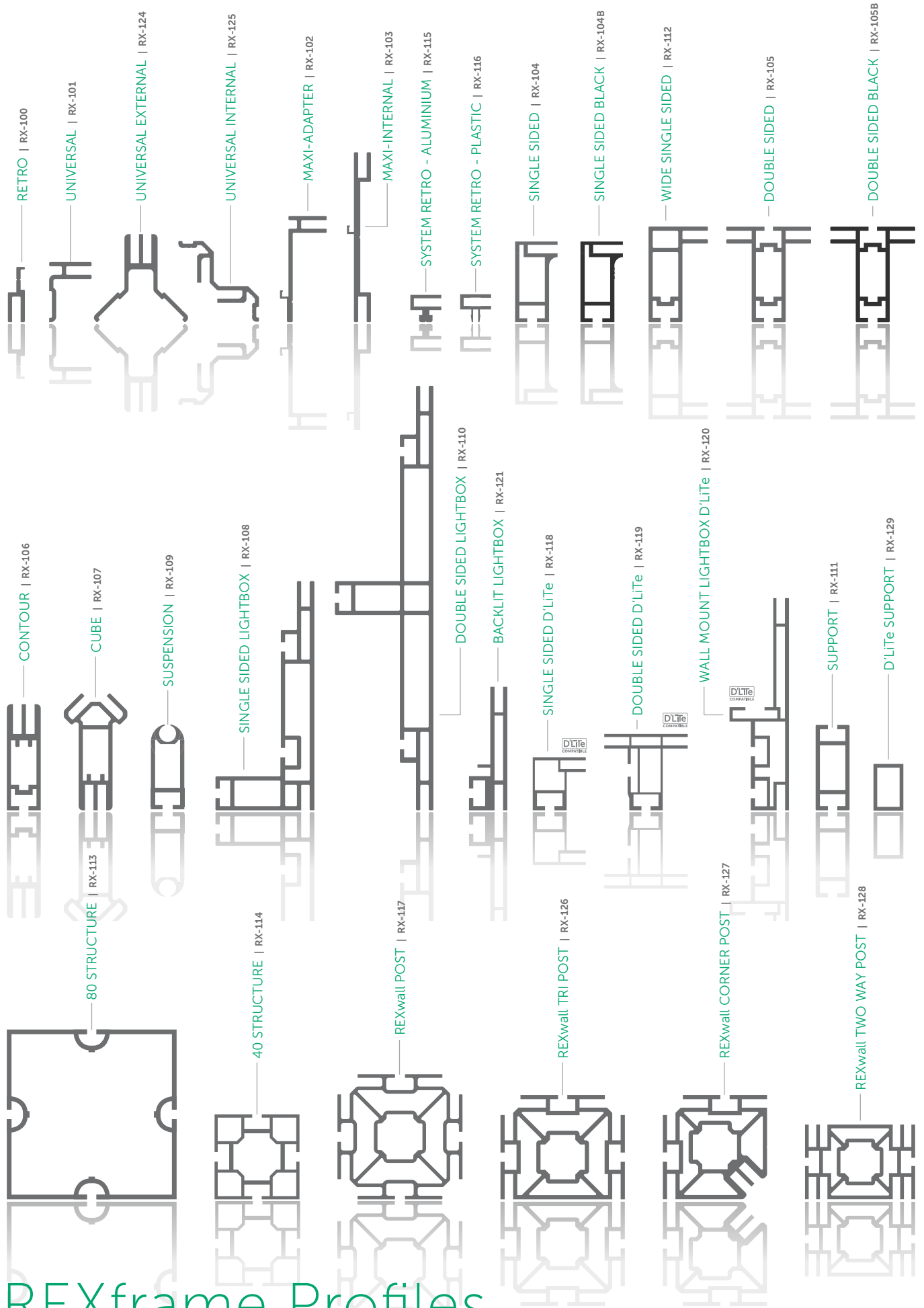



Single Sided Knuckle | RX-200

Double Sided Knuckle | RX-202

Standard Elbow | RX-203

Heavy Duty Elbow | RX-204

Heavy Duty Joiner | RX-205



T-Nut | RX-206

Knurled Nut | RX-207

Wall Clip | RX-208

Eyebolt | RX-209

U-Bolt | RX-210



40 Structure Lock | RX-211

90° Lock | RX-212

45° Lock (Right) | RX-213-R

45° Lock (Left) | RX-213-L

Heavy Duty Feet | RX-216



80 Structure Lock | RX-217

Cube Clamp | RX-222

Silicon Rubber Strip | RX-223

Corner Brace | RX-224

Flat Elbow | RX-225

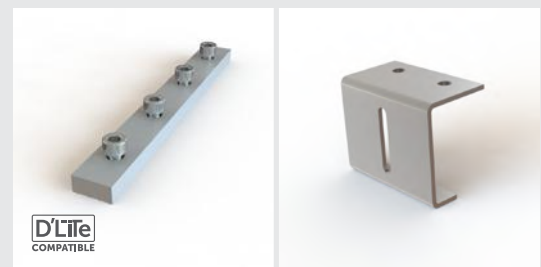

Standard Joiner | RX-226

105 Bracket | RX-227

REXframe Accessories



Standard Feet | [RX-228](#)



Coupling Bolt | [RX-229](#)



Tool Free Elbow | [RX-230](#)

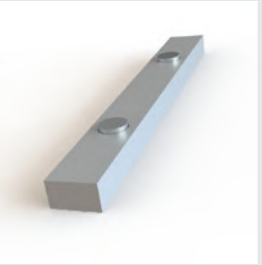

Tool Free Joiner | [RX-231](#)

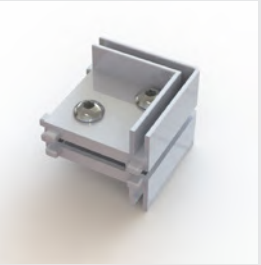

105 Corner Knuckle | [RX-232](#)



108 Cube Knuckle | [RX-233](#)



110 Cube Knuckle | [RX-234](#)



Flat Feet | [RX-235](#)



L Shaped Feet | [RX-236](#)



L Shaped Feet (Black) | [RX-236B](#)



Obtuse Angle 'Wing' Kit | [RX-241](#)



Acute Angle 'Disc' Kit | [RX-242](#)



Rigging Profile Ring | [RX-243](#)



Heavy Duty T-Nut | [RX-244](#)

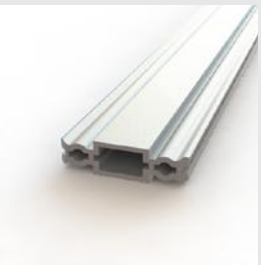

80 Structure Joiner | [RX-245](#)



108 Corner Knuckle | [RX-246](#)

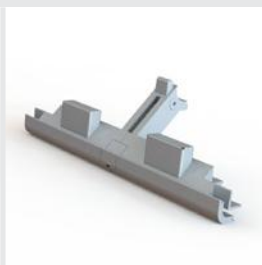

110 Corner Knuckle | [RX-247](#)



Magnetic Shelf Kit (Small) | [RX-248](#)



Magnetic Shelf Kit (Large) | [RX-249](#)



Acrylic Shelf | [RX-250](#)



40 Structure Cap | [RX-252](#)



80 Structure Cap | [RX-253](#)

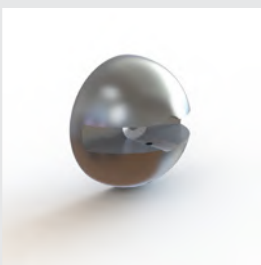

Heavy Duty Shelf Adapter | [RX-254](#)



Adjustable Heavy Duty Elbow | [RX-255](#)



45 Degree Knuckle | [RX-256](#)



60 Degree Knuckle | RX-257



REXwall Post Cap | RX-258

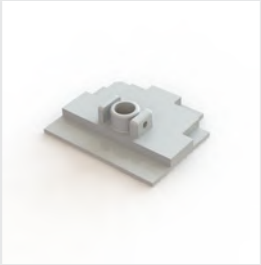

REXwall Tri Post Cap | RX-259



REXwall Corner Post Cap | RX-260



Universal Internal Knuckle | RX-261



Universal External Knuckle | RX-262



REXwall Adjustable Foot | RX-263



108 Curved Corner | RX-264



Hinge | RX-267



Door Magnet | RX-268



Door Stop | RX-269



Door Handle | RX-270



REXkey Kit | RX-404



Drill Guide | RX-405



Knuckle Drill Bit | RX-406



Lock Drill Bit | RX-407



Gasket Sewing Guide | RX-408



Sample Kit | RX-409



Pneumatic punch | RX-410



POS Kit | RX-500

REXframe Tools



9-Light Module | [RX-300](#)



9-Light Dimmable Module | [RX-300-DIM](#)



9-Light Mini Module | [RX-300-MINI](#)



5-Light Module | [RX-301](#)



5-Light Dimmable Module | [RX-301-DIM](#)



6 AMP Transformer | [RX-303](#)



3" Connector | [RX-304](#)



12" Connector | [RX-305](#)



6ft Connector | [RX-306](#)



Single Module Transformer | [RX-307](#)



Halogen Arm Light | [RX-308](#)



LED Arm Light | [RX-309](#)



Parallel Connector | [RX-310](#)



RGB 5-Light Module | [RX-311](#)



RGB Standard Controller | [RX-312](#)



RGB Programmable Controller | [RX-313](#)



LadderEX Module | [RX-314](#)

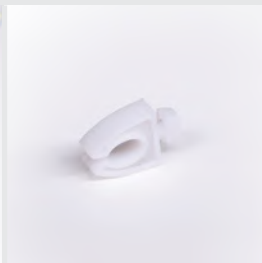

Single Wire Clip | [RX-316](#)



Multi Wire Clip | [RX-317](#)



10/6 Module Wire Harness | [RX-318](#)



20/12 Module Wire Harness | [RX-319](#)



30/18 Module Wire Harness | [RX-320](#)



40/24 Module Wire Harness | [RX-321](#)

REXframe Lighting



8' 318
Extension | [RX-322](#)



8' 319
Extension | [RX-323](#)



8' 320
Extension | [RX-324](#)



8' 321
Extension | [RX-325](#)



Power
Repeater | [RX-326](#)



Dimmer | [RX-327](#)



13.5 AMP
Transformer | [RX-330](#)



25 AMP
Transformer | [RX-331](#)



3.125 AMP Inline
Transformer | [RX-332](#)



Power Lead
For 332 | [RX-333-US](#)



Connecting Lead
For 332 | [RX-334](#)



7.5 AMP
Transformer | [RX-335](#)



End Cap
For 332 | [RX-336](#)



314 Saddle | [RX-340](#)



314 Screws | [RX-341](#)



314 Wire
White | [RX-342-WHITE](#)

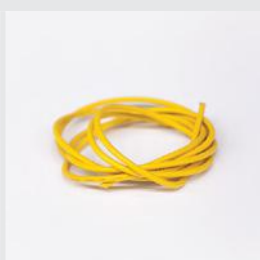

314 Wire
Yellow | [RX-342-YELLOW](#)



Inline
Adapter | [RX-343](#)



314 Clip | [RX-344](#)



Wire
Connector | [RX-345](#)



REXframe Lightbox walls



REXframe hanging cube



REXframe stand with curved hanging features

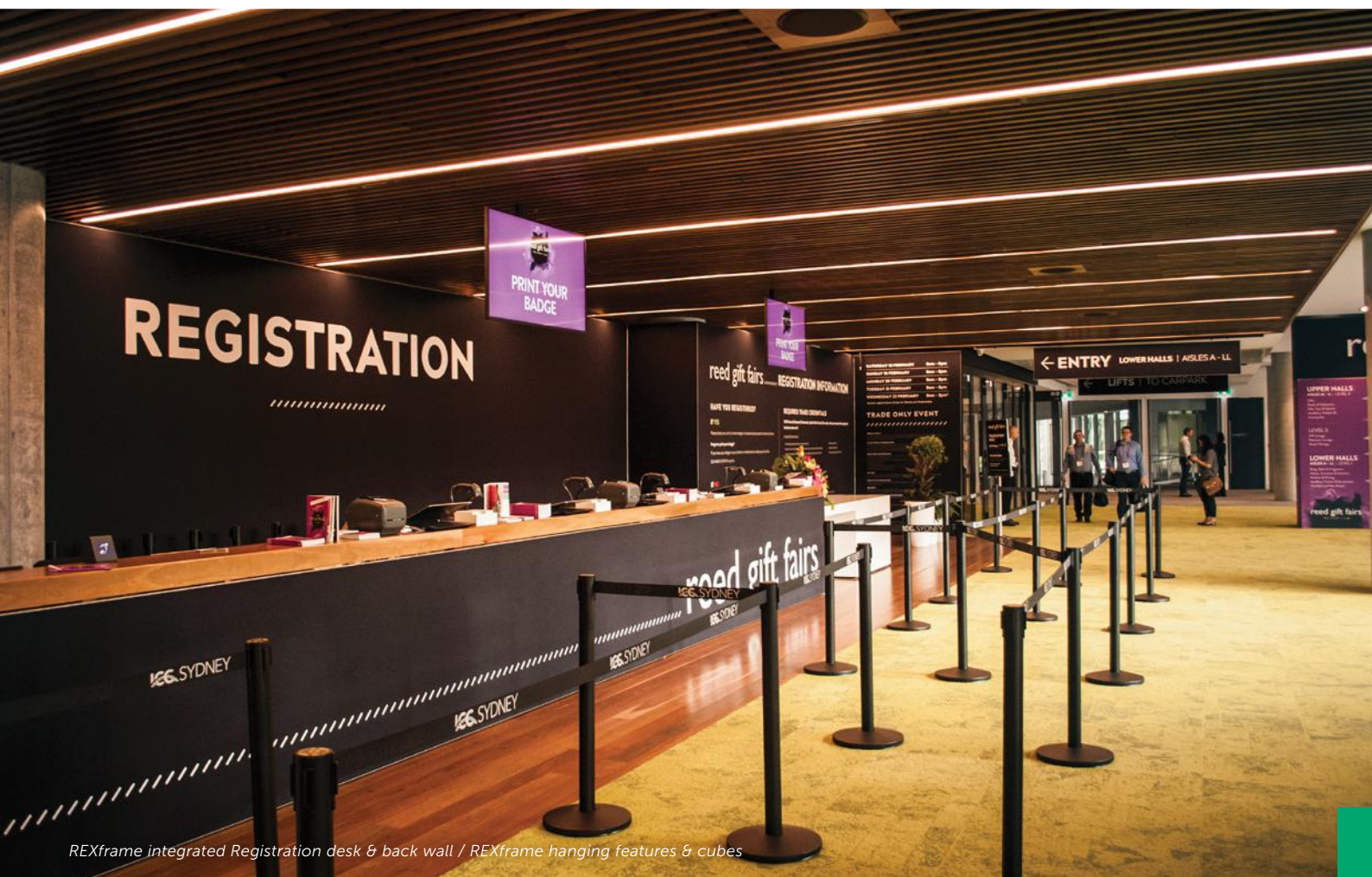

REXframe integrated Registration desk & back wall / REXframe hanging features & cubes

www.REXframe.com