

Modular Brand Spaces.



The exhibition display system which can be used for more than an exhibition stand!



Make it happen. Space for your brand!

We offer a flexible display system that opens up lots of possibilities.
Experience a combination of simplicity and flexibility, where you can manage your own exhibition stand, or sit back and let us manage the logistics and installation.

Ayble can be used in many environments to maximise your branding opportunities and customer interface.

Welcome to a world of possibilities:
Welcome to ayble.



1.1 Customer Testimonials

Your satisfaction is our mission!

ayble closes the gap between equipment for small events and for conventional exhibition stands for larger events. It gives us a system for worldwide coverage and the feedback from our local offices are only positive.

Robert Stecher
ROHDE & SCHWARZ GmbH & Co. KG



The perfect solution for a wide variety of events – and the robust system guarantees quick assembly and dismantling.

Stephan Kube, Retail Marketing Manager
Crown

A simple promotional tool enabling innovative companies to optimise their presentations.

Christina Plank, Marketing
Baur



At a glance:



Easy

Build your stand layout in minutes without stress and without tools

With the simple transport system, your next event is in easy reach!



Flexible

Be it an exhibition stand, point of sale or event, our system can be used for most branding opportunities use for any occasion and thanks to the modular concept adapt to your individual needs!



Profitable

You save money without compromising on quality! You can rely on a quality product designed and made in Germany, which is renowned for its reusability and durability. A system which quickly pays off for you.



Tool-free Construction

Connect frames and accessories quickly and easily with our connectors. In no time construct a complete stand without the need of any tools

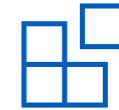

Modular System

Change your frame configuration as and when required. Make your stand larger and smaller from event to event. Update your graphic panels easily as and when your branding changes. There are no limits to creativity!



Multifunctional Use

You have lots of options, but just the one system. Use it for exhibitions, conferences, info points or anywhere where you want your message to be seen



Easy Transportation

Our system is designed for quick and easy transportation. Compact storage means that the next event is as easy as the previous one.



Reusable

ayble will show cost savings even after a few events. Buy once and then keep reinventing your displays, all with the reassurance of a 10 year warranty.



A Complete Solution

Let us take the stress of arranging your logistics, installation and storage. We can support from the design layout through to the install, breakdown and storage for your whole events calendar.

1.2 Modular

One system – many options

With our system you will have lots of options for your stand layout across your events. For example, if your system consists of 12 frames you can create over 100 different configurations. Here you can see three possibilities.



3 out of over 100 possible combinations

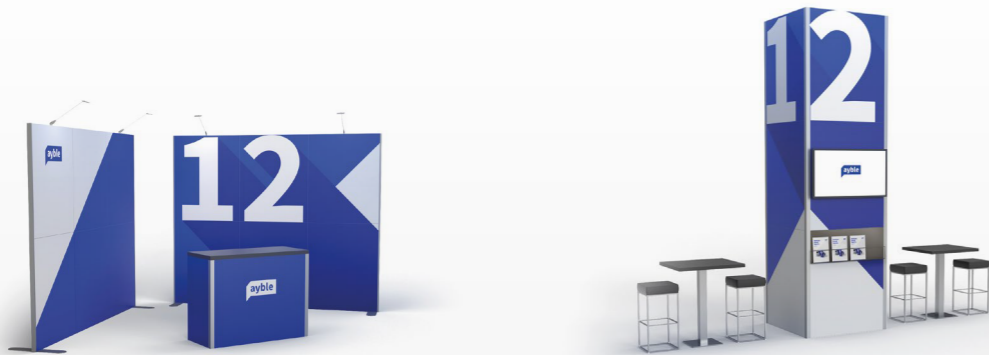

1.3 Flexibility



2 Frames



6 Frames



9 Frames



13 Frames



18 Frames



24 Frames



24 Frames



36 Frames



58 Frames



64 Frames



174 Frames

You can order additional framework at any time giving endless possibilities!

1.4 Accessories

Made to measure upgrades

Would you like to expand and enhance your exhibition system?
 We offer an extensive range of accessories, from lighting to screens to brochure holders.
 Everything to maximise your exposure at any event.

Want to discuss your specific stand requirements? Talk to us and we will show you the best solutions.



01 Frame

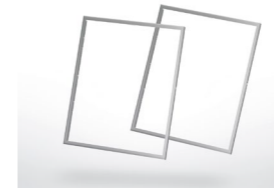

02 Door



03 Corner & End Profile



04 Panel



05 Wooden Panel

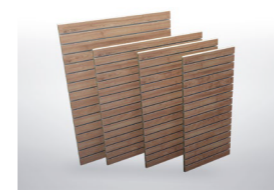

06 Connector

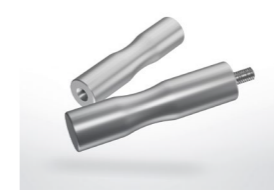

07 Feet

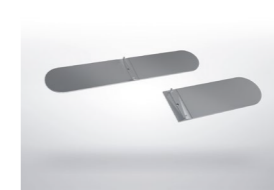

08 LED Light



09 Hinges

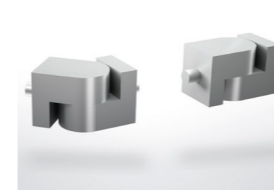

10 Brochure Holder

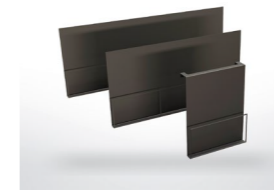

11 Shelf Profiles



12 TV Bracket

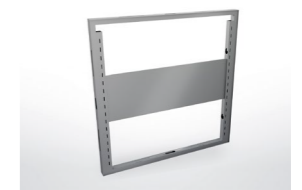

13 TV



14 Shelf

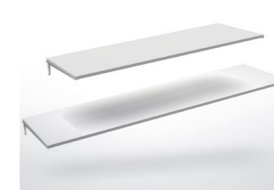

15 Counter

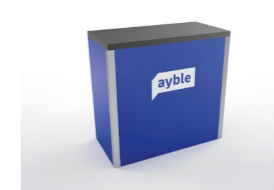

16 Counter



17 Connector Bag



18 Panel Bag



19 Trolley



20 Flight Case



Quick and easy to set up – without any tools

Everything fits and everything is assembled quickly, even after many years of use. The special ayble connectors and the magnetic graphic panels, makes assembly a breeze. The finished stand is heavy and durable, but the individual frames and components are lightweight, making assembly and dismantling an easy job for just one or two people.

A. Frame sizes:

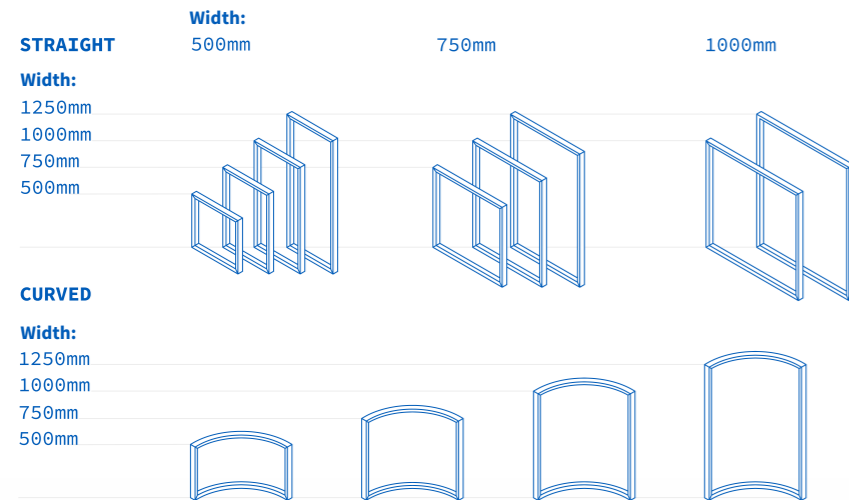

B. Connect frame with connectors:

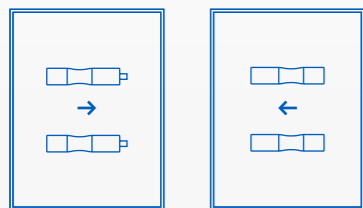

C. Insert magnetic graphic panels:

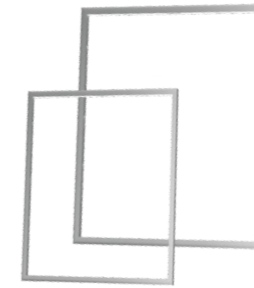
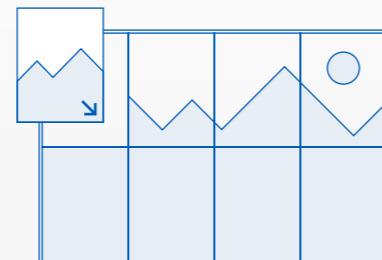

Frame sizes for every need

Our frames impress due to high quality manufacturing. We use lightweight premium aluminium profiles which are flame retardant. Variable and even bespoke frame sizes help to design maximum stand configuration flexibility.

Connect the frames in no time

You will enjoy the simplicity of construction when building your stand. The frames are connected with the special ayble connectors which simply screw together. During transport they can be used to fit the frames to the transportation trolley.



High impact graphic panels

Ayble is the perfect solution for quickly and easily changing your branding from event to event. Multiple sets of panels can be produced for one set of frames, allowing multiple branding opportunities.



1.5 Storage and transportation

Everything has a place!

Trolley, panel bag and flight cases available. With these options you can store and transport your ayble system easily from event to event. We can also offer a logistics service where we store, transport and even install and dismantle your stands.

01

Trolley

Up to six frames can fit onto one trolley. Frames are fixed to the trolley with male connectors so everything is safely stored and can easily be transported.

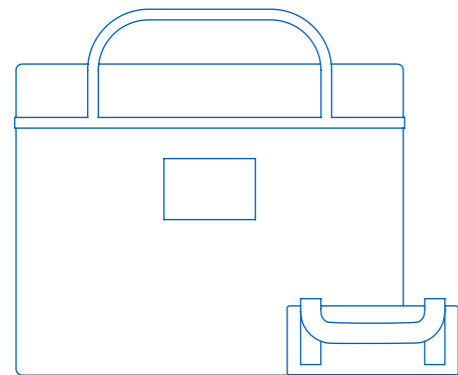
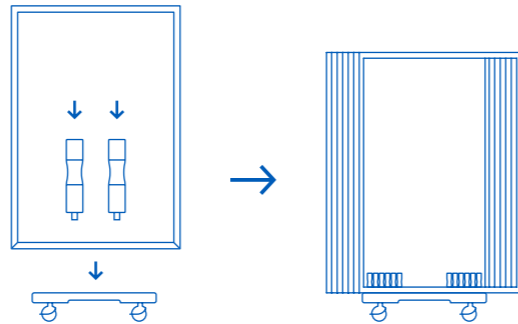

02 03

Carrying case for graphic panels & connectors

Simply fit over your shoulder – and off you go: up to 10 graphic panels can fit in one graphic panel case.

Don't want to transport and install yourself? No problem! On the next pages you will learn more about our services.



04

Flight Case

Do you send your exhibition stands worldwide? Then our flight case is a good option to store and protect your equipment. Up to 10 frames, 20 panels as well as profiles, connectors, lights, TV and brochures can fit inside a flight case. It is designed for a standard Euro pallet dimension so that shipping is as inexpensive as possible!



Services.

We offer a range of services with the focus on each customer getting exactly the kind of support they want with their ayble event stands. This can be just the supply of framework right through to storage with event installation and dismantling. We will adapt the level of support to your requirements. You can take advantage of our 'Service Plus' offers detailed on this page.

Free Service



Individual Advice

Together we can develop the optimal solution for your exhibition stand, face to face, online meetings, by phone or by email.



Technical Drawings

We will produce technical drawings for you free of charge, so you can visualise your stand.



Emergency Service

We are also there for you during the event! Quick help is there is something unexpected happens.

Service Plus



Graphic Display

We will be happy to develop the artwork for your graphic panels. We can develop a concept for you that will attract and inspire people.



Convenient assembly and dismantling

We will make sure that your stand is on site and assembled for your deadline. We will take care of everything including construction and dismantling, installing electrical services, delivering equipment and supplying floor plans and health and safety documentation to the event organiser.



Logistics

If you don't want to worry about event equipment transportation, we can take care of everything. Relax and leave it to us!



Practical Storage

The event is over and you don't know where you are going to store your system? We will gladly take care of that for you and ensure your stand is in perfect condition for your next event.

1.7 Multiple Uses

A system for everything.

Using different display solutions for a variety of events?
 This can be an expensive way which eats up your events budget.
 With our solution you get one system which can be used across brands
 and audiences to maximise your budget and give a better return on investment.

Number of Frames
 Approximate Construction Time
 Persons Required

Up to 5m²

Ideal for POS, reception displays,
 sponsorship and press backdrops



6 Frames
 Approx. 10 Minutes
 1 Person



7 Frames
 Approx. 10 Minutes
 1 Person



6 Frames
 Approx. 10 Minutes
 1 Person

Up to 10m²

Need help to find an outstanding solution?
 No problem, we will deliver a proposal to
 meet all of your requirements!



12 Frames
 Approx. 20 Minutes
 1 Person



16 Frames
 Approx. 30 Minutes
 1 Person



9 Frames
 Approx. 20 Minutes
 1 Person

Up to 15m²



18 Frames
 Approx. 25 Minutes
 1 Person



18 Frames
 Approx. 25 Minutes
 2 People



18 Frames
 Approx. 25 Minutes
 2 People

Up to 20m²



38 Frames
Approx. 60 Minutes
2 People



26 Frames
Approx. 60 Minutes
1 Person



40 Frames
Approx. 120 Minutes
2 People

Up to 30m²

Did you know your first 3D stand design is free of charge?



36 Frames
Approx. 90 Minutes
1 Person



30 Frames
Approx. 60 Minutes
2 People



36 Frames
Approx. 80 Minutes
2 People

Up to 40m²

When express delivery is needed – we can deliver in around one week for standard products and printed graphic panels.



64 Frames
Approx. 180 Minutes
2 People



60 Frames
Approx. 180 Minutes
2 People

Over 100m²



174 Frames
Approx. 360 Minutes
3 People

Counters



3 Frames
Approx. 5 Minutes
1 Person



3 Frames
Approx. 5 Minutes
1 Person



1 Frames
Approx. 2 Minutes
1 Person

Pylons



1 Frames
Approx. 2 Minutes
1 Person



1 Frames
Approx. 5 Minutes
1 Person



2 Frames
Approx. 5 Minutes
1 Person

Want to find out more?

No problem – we will be happy to help you find the perfect bespoke solution. Call us without any obligation or send us a message.

01245 325743

hello@ayble.co.uk

www.ayble.co.uk

Nikon



Panels
22

Construction Time
40 Minutes

No. of People
3

Use
Trade Show

Sparkasse



Panels
22

Construction Time
25 Minutes

No. of People
2

Use
Event

Althaus Tee

Take advantage of the flexibility of your system - for example transform it to a point of sale display!



Panels	Construction Time	No. of People	Use
22	40 Minutes	1	Event



Panels	Construction Time	No. of People	Use
22	20 Minutes	1	PoS

Want to talk?

Just call: 01245 325743

Or email: hello@ayble.co.uk



If you haven't found your answer in this brochure, just ask us.

We will work in partnership with you and make sure we meet your aims and objectives.

We look forward to speaking with you!



Modular Brand Spaces.